



Surgical Catalogue



NOXBAY

Serving Your Health With Excellence

*Professional Instruments
for Professional Users*



Magill

NI-2-101-15

Catheter Introducing Forceps
14.5 cm , 20cm, 25 cm



Miller

NI-1-101-18

Laryngoscope Sets



Millar-Baby

NI-2-103-00

Laryngoscope Sets



Miller

NI-2-104-00

Laryngoscope Blade
Fig. 0, Fig. 1, Fig. 2, Fig. 3, Fig. 4



Guedel-Negus

NI-2-105-00

Laryngoscope Sets
Fig. 2, Fig. 3, Fig. 4



Guedel-Negus

NI-2-106-00

Laryngoscope Sets
Fig. 1, Fig. 2, Fig. 3, Fig. 4



Guedel-Negus

NI-2-107-01

Laryngoscope Blades

Fig. 1, Fig. 2, Fig. 3, Fig. 4



McIntosh

NI-2-108-00

McIntosh



McIntosh

NI-2-109-0

Laryngoscope Blades

Fig. 0, Fig. 1, Fig. 2, Fig. 3, Fig. 4



McIntosh

NI-2-110-00

Laryngoscope Sets

Fig. 1, Fig. 2, Fig. 3, Fig. 4



Foregger

NI-2-111-01

Laryngoscope Blades

Fig. 1, Fig. 2, Fig. 3, Fig. 4



Battery Handle

NI-2-112-00

Battery Handle



McIntosh

NI-2-114-00

Laryngoscope Sets fiber optic

Fig. 1, Fig. 2, Fig. 3



McIntosh

NI-2-115-00

Laryngoscope Sets fiber optic

Fig. 1, Fig. 2, Fig. 3



McIntosh

NI-2-116-00

Laryngoscope Sets fiber optic

Fig. 1, Fig. 2, Fig. 3



McIntosh

NI-2-113-00

Laryngoscope Sets

Fig. 1, Fig. 2, Fig. 3, Fig. 4



Universal

NI-3-101-04

Trocar
14 cm



Nelson

NI-3-102-07

Trocar
20cm



Lichtwitz

NI-3-103-19

Antrum Trocar
18.5 cm



Adson

NI-3-104-21

Suction Cannula
20cm



Frazier

NI-3-105-10

Suction Cannula
24 cm



Frazier

NI-3-106-06

Suction Cannula
19.5 cm



Poppen

NI-3-107-06

Suction Cannula
18 cm



Luer

NI-3-108-30

Suction Tube working length 110 mm



Yasargil

NI-3-109-15

Suction Tube working length 150 mm with
Luer hub



Yankauer

NI-3-110-27

Suction Tube complete with suction tip
and connector
31 cm



Yankauer

NI-3-111-00

Suction Tube
31 cm , 15 cm, 2.5 cm, 10 cm



Poole

NI-3-112-22

Suction Tube
22cm



Poole

NI-3-113-22
Suction Tube
22.5 cm



Nuboer

NI-3-114-21
Suction Tube
21cm



Nuboer

NI-3-115-21
Suction Tube
21cm



Quinke

NI-3-116-10
Lumbar Puncture Needle



Tuohy

NI-3-117-12
Lumbar Puncture Needle Luer Lock
connection with special tip



Verres

NI-3-118-20
Insufflation Cannula Luer Lock connection
15 cm



Verres

NI-3-119-20

Insufflation Cannula Luer Lock connection
17 cm



Kalt

NI-4-105-14

Needle Holder
13.5 cm



Barraquer-Troutman

NI-4-106-10

Micro Needle Holder
10 cm , 10.5 cm



Arruga

NI-4-107-14

Micro Needle Holder
13.5 cm



Barraquer-Troutman

NI-4-108-10

Micro Needle Holder
10.5 cm , 11.5cm



Barraquer

NI-4-109-11

Micro Needle Holder
11.5cm, 13.5 cm , 14 cm



Barraquer

NI-4-110-13

Micro Needle Holder
13.5 cm



Castroviejo-Fino

NI-4-111-01

Micro Needle Holder
13cm



Castroviejo-Fino

NI-4-112-01

Micro Needle Holder
13cm



Castroviejo-Fino

NI-4-113-01

very delicate jaw with lock
13cm



Castroviejo

NI-4-114-14

Micro Needle Holder with lock
Fig.65, Fig.69, Fig.88 L, 14 cm



Castroviejo

NI-4-115-14

Micro Needle Holder
14 cm



Castroviejo

NI-4-121-14

Micro Needle Holder with lock
14 cm



Castroviejo

NI-4-122-14

Micro Needle Holder
14 cm



Castroviejo

NI-4-124-13

Micro Needle Holder with lock

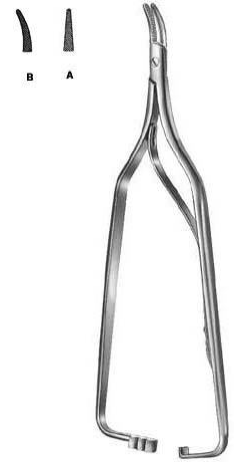

Arruga

NI-4-123-16

Needle Holder delicate
16 cm



Castroviejo

NI-4-125-12

Micro Needle Holder with lock
12 cm



Derf

NI-4-126-12

Needle Holder
12 cm, 13cm

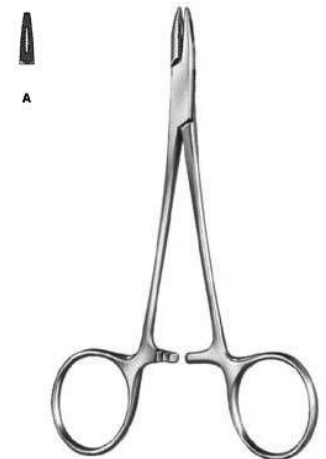

Collier

NI-4-127-12

Needle Holder
12.5 cm



Webster

NI-4-128-13

Needle Holder

13cm

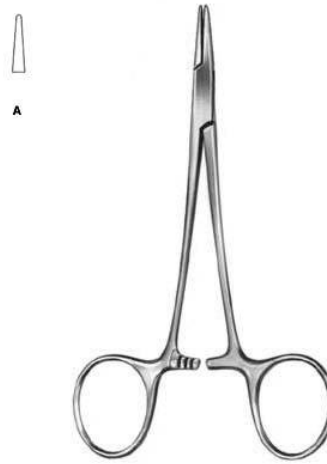

Halsey

NI-4-129-13

Needle Holder

13.5 cm



Neivert

NI-4-130-13

Neivert

12.5 cm



Metzenbaum

NI-4-141-18

Needle Holder one grooved and fenestrated jaw

18.5 cm



M. G. Hospital

NI-4-142-17

Needle Holder

17.5 cm



Mayo-Hegar

NI-4-143-14

Needle Holder

14.5 cm , 16 cm , 18.5 cm , 24 cm



Adson

NI-4-140-18

Needle Holder one fenestrated jaw
18 cm



Metzenbaum

NI-4-141-18

Needle Holder one grooved and
fenestrated jaw
18.5 cm



M. G. Hospital

NI-4-142-17

Needle Holder
17.5 cm



Mayo-Hegar

NI-4-143-14

Needle Holder

14.5 cm , 16 cm , 18.5 cm , 20.5 cm , 24 cm
, 26.5 cm



Brown

NI-4-145-13

Needle Holder

13cm, 18 cm



Mayo Hegar

NI-4-144-16

Needle Holder

16 cm , 18.5 cm , 20.5 cm

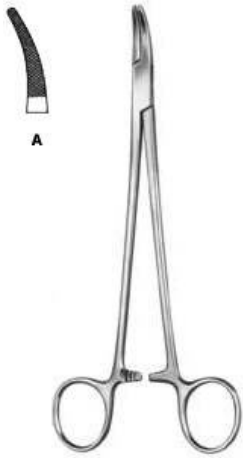

Heaney

NI-4-146-21

Needle Holder
20.5 cm

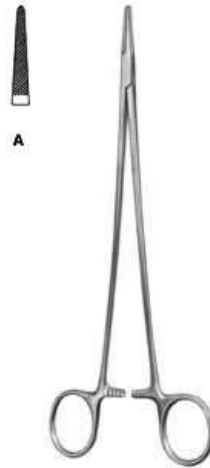

Jamison

NI-4-147-23

Needle Holder
23.5 cm



Masson

NI-4-148-27

Needle Holder
26.5 cm

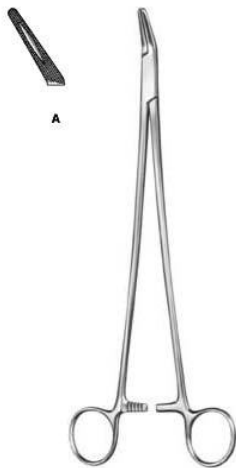

Finochietto

NI-4-149-27

Needle Holder
26.5 cm



Wangenstein

NI-4-150-27

Needle Holder
26.5 cm

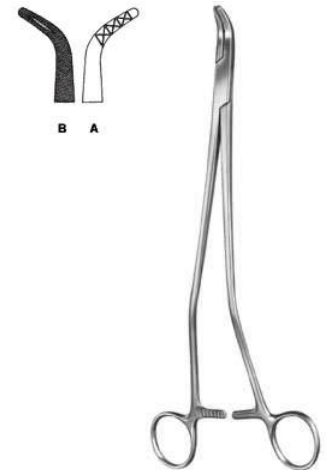

Johnson

NI-4-151-27

Needle Holder
27 cm

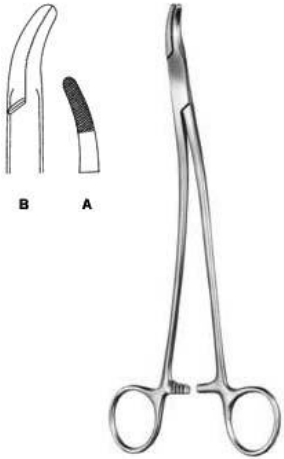

Stratte

NI-4-152-23

Needle Holder
23 cm

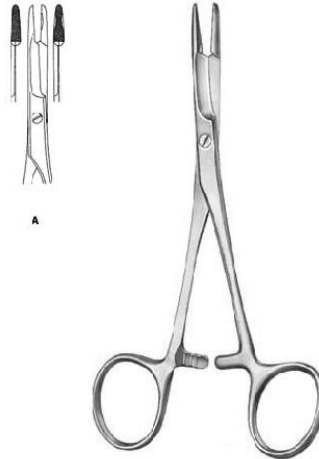

Olsen-Hegar

NI-4-153-14

Needle Holder
14 cm

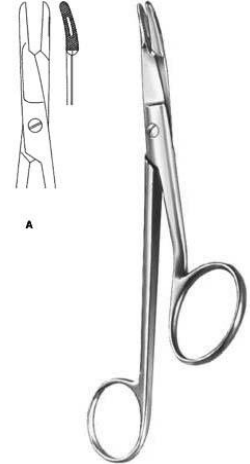

Gillies

NI-4-154-16

Needle Holder
16 cm



Crile

NI--155-15

Needle Holder
15 cm



Mathieu

NI-4-156-14

Needle Holder
14 cm, 17 cm , 20cm



Mathieu

NI-4-157-14

Needle Holder
16.5 cm



Toennis

NI-4-158-18

Needle Holder

18.5 cm



Lichtenberg

NI-4-159-20

Needle Holder

20cm



Micro Needle Holder

NI-4-160-16

Micro Needle Holder

16 cm

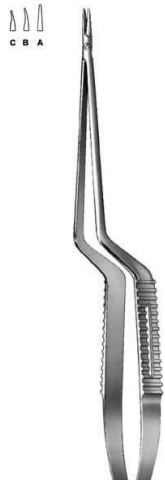

Micro Needle Holder

NI-4-161

Micro Needle Holder

19 cm



Hepp-Scheidel

NI-4-162-18

Micro Needle Holder smooth jaw

18 cm

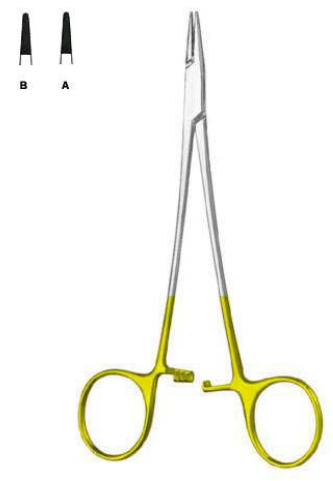

Webster

NI-4-163-13

Needle Holder with automatic release ratchet also for lefthanders

Fig.233, 16 cm , 12 cm, 13cm, 15 cm



Micro Needle Holder

NI-4-164-15

Micro Needle Holder
15 cm, 18 cm, 21cm, 23 cm



JABOMA

NI-4-165-18

Micro Needle Holder
18 cm



Castroviejo

NI-4-166

Micro Needle Holder
Fig.233, 16 cm , 12 cm, Fig.18 L, 14.5 cm ,
18 cm, 21cm



Arruga

NI-4-167

Needle Holder
Fig.233, 16 cm , 12 cm, Fig.18 L, 16 cm



Castroviejo

NI-4-168-13

Micro Needle Holder
12.5 cm



Barraquer

NI-4-169-13

13 cm



Barraquer

NI-4-170-13

Micro Needle Holder
13 cm



Webster

NI-4-171-13

Needle Holder
13 cm



Derf

NI-4-173-12

Needle Holder
12 cm



Kilner

NI-4-172-13

13 cm



Hegar-Baumgartner

NI-4-174-13

Needle Holder
13 cm , 14.5 cm



Halsey

NI-4-175-12

Needle Holder
13 cm , 12 cm



Crile-Wood

NI-4-176-15

Needle Holder
15 cm



Sarot

NI-4-177-18

Needle Holder
18 cm, 20 cm, 26 cm

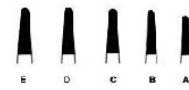

Mayo-Hegar

NI-4-178-16

Needle Holder standard profile
16 cm, 18 cm, 20 cm, 24 cm, 26 cm, 30 cm



Heaney

NI-4-179-20

Needle Holder
20 cm, 24 cm, 26 cm

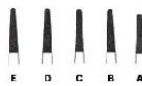

DeBakey

NI-4-180-18

Needle Holder delicate pattern mini profile
18 cm, 20 cm, 23 cm, 26 cm, 31 cm



Masson

NI-4-181-27

Needle Holder
26.5 cm



Ryder (Martin)

NI-4-182-13

Needle Holder

12.5 cm, 15 cm, 18 cm, 20 cm, 23 cm, 26 cm

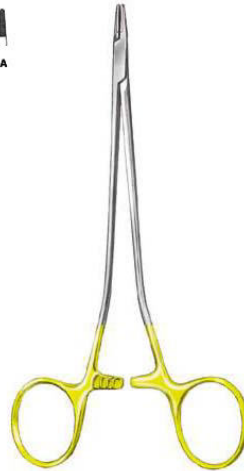

Martin

NI-4-183-15

Needle Holder mini profile elastic type

15 cm, 17 cm, 20 cm



Wangensteen

NI-4-184-27

Needle Holder standard profile

27 cm



Hegar-Vascular

NI-4-185-14

Needle Holder micro profile

14 cm, 18.5 cm, 20.5 cm, 23 cm

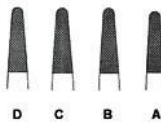

Bozemann

NI-4-186-20

Needle Holder standard profile

20.5 cm, 24 cm, 26.5 cm, 29 cm



Hegar

NI-4-187-20

Needle Holder standard profile

20 cm, 23.5 cm

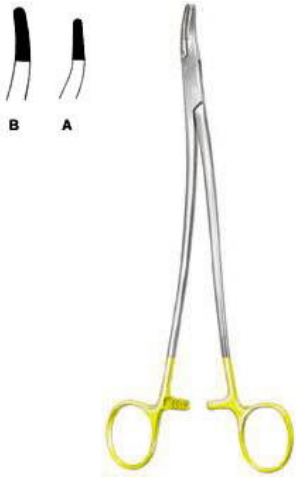

Stratte

NI-4-188-22

Needle Holder standard profile
23 cm

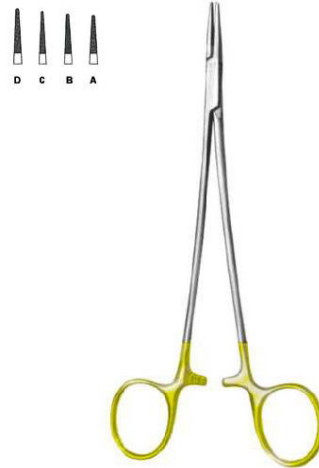

Microvascular

NI-4-189-00

Needle Holder slender pattern micro
profile
14 cm, 17.5 cm, 20 cm, 23 cm



Mathieu

NI-4-190-14

Needle Holder
14 cm, 17 cm, 20 cm



Mathieu

NI-4-191-14

Needle Holder
14 cm, 17 cm, 20 cm



Mathieu

NI-4-192-17

Needle Holder standard profile with
interior ratchet
17 cm, 20 cm, 23 cm



Toennis

NI-4-193-18

Needle Holder
18.5 cm



Lichtenberg

NI-4-194-20

Needle Holder lightweight model
standard profile
20 cm



Langenbeck

NI-4-195-18

Needle Holder
18 cm, 20.5 cm, 23 cm



Zweifel

NI-4-196-20

Needle Holder with hinged ratchet
standard profile
20.5 cm, 23 cm



Reverdin

NI-4-197-15

Reverdin Needle short
14 cm Fig. 1, 14 cm Fig. 2, 14 cm Fig. 3,
14 cm Fig. 4

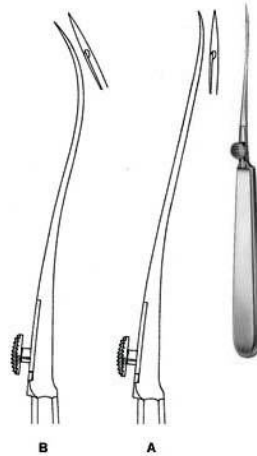

Reverdin

NI-4-198-19

Reverdin Needle medium
19.5 cm Fig. 1, 19.5 cm Fig. 2, 19.5 cm Fig.
3, 19.5 cm Fig. 4

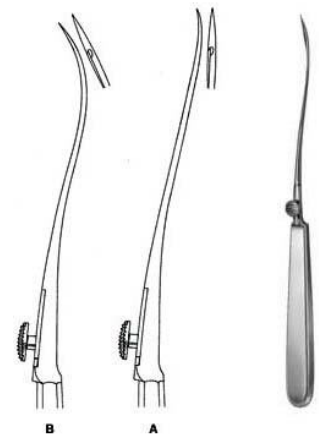

Reverdin

NI-4-199-23

Reverdin Needle long
23 cm Fig. 1, 23 cm Fig. 2, 23 cm Fig. 3, 23
cm Fig. 4

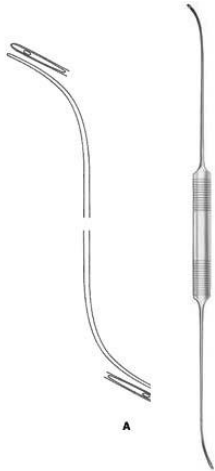

Schmieden-Dick

NI-4-201-01

Ligature Needle malleable
29 cm

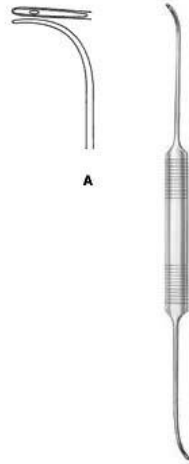

Schmieden

NI-4-202-21

Ligature Needle
24 cm



Ligature Needle Malleable

NI-4-203-20

Ligature Needle malleable
20.5 cm

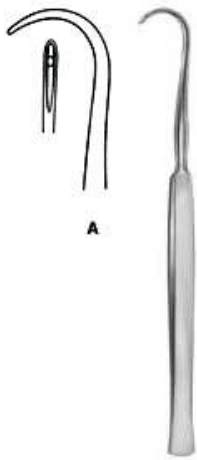

Cooper

NI-4-204-19

Ligature Needle
18.5 cm



Kronecker

NI-4-205-13

Ligature Needle delicate for right hand
12.5 cm

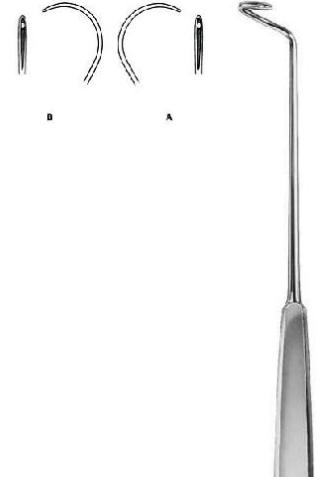

Deschamps

NI-4-206-24

24 cm

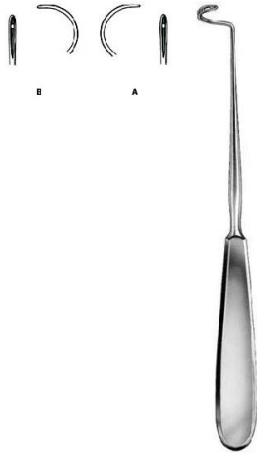

Deschamps

NI-4-207-20

Ligature Needle blunt for right hand
20 cm

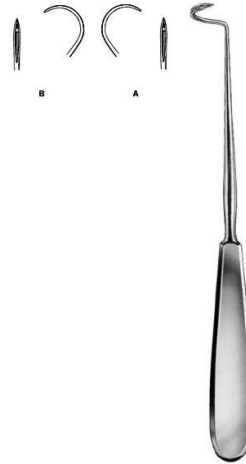

Deschamps

NI-4-208-20

Ligature Needle sharp for right hand
20 cm

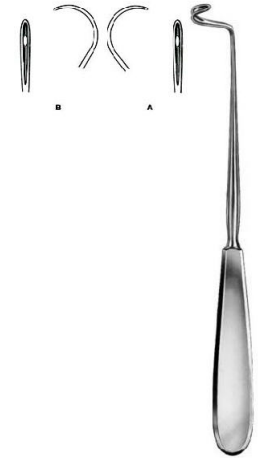

Deschamps

NI-4-209-21

Ligature Needle blunt for right hand
20 cm



Deschamps

NI-4-210-21

Ligature Needle sharp for right hand
20 cm

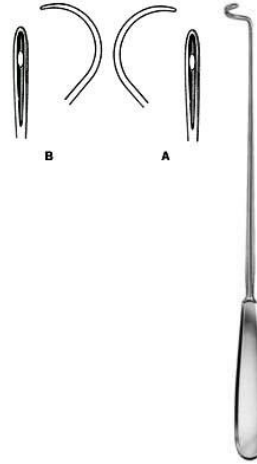

Deschamps

NI-4-211-27

Ligature Needle blunt for right hand
27 cm

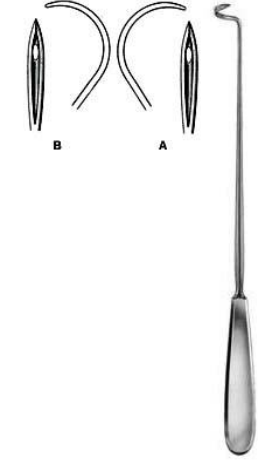

Deschamps

NI-4-212-27

Ligature Needle sharp for right hand
27 cm

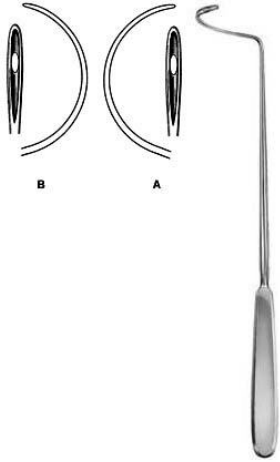

Deschamps

NI-4-213-28

28 cm

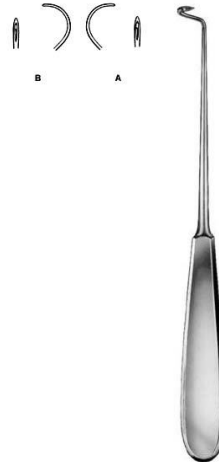

Deschamps

NI-4-214-20

Ligature Needle sharp for right hand
20 cm



Deschamps

NI-4-215-20

Ligature Needle blunt for right hand
20 cm



Deschamps

NI-4-216-20

Ligature Needle blunt for right hand
21 cm

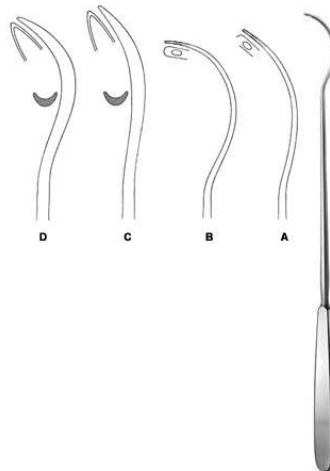

Brunner

NI-4-217-30

Ligature Needle
21 cm



Kirschner

NI-4-218-25

Ligature Conductor
25.5 cm

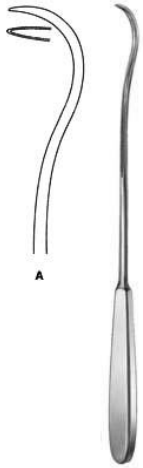

Ligature Conductor

NI-4-219-28

Ligature Conductor
28 cm



Modell Wien

NI-4-220-23

Ligature Catcher
23.5 cm



Michel

NI-4-221-12

Clip Applying Forceps
12 cm



Hegenbarth

NI-4-222-12

Clip Applying Forceps
12 cm



Dissecting Knife

NI-5-101-01

Dissecting Knife with metal handle
15 cm, 15.5 cm, 16 cm , 17 cm



Autopsy Knife

NI-5-102-10

Autopsy Knife
25.5 cm

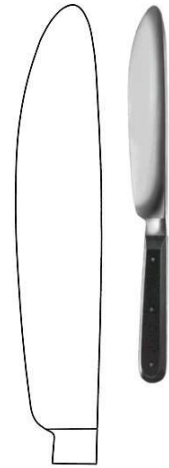

Walb

NI-5-104-17

Post Mortem Knife

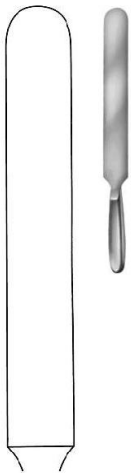

Virchow

NI-5-105-20

Virchow

28.5 cm, 33.5 cm, 38 cm



Scalpel Handle

NI-5-108-04

Scalpel Handle
13.5 cm



Scalpel Handle

NI-5-109-34

Scalpel Handle
16 cm



Scalpel Handle

NI-5-110-41

Scalpel Handle
21cm



Scalpel Handle

NI-5-111-45

Scalpel Handle
21cm



Collin

NI-5-112-08

Scalpel Handle with hollow handle
13.5 cm



Collin

NI-5-113-09

Scalpel Handle with hollow handle
14.5 cm



Scalpel Handle

NI-5-114-03

Scalpel Handle
12 cm



Scalpel Handle

NI-5-115-04

Scalpel Handle
12 cm



Scalpel Handle

NI-5-116-05

Scalpel Handle
12 cm



Scalpel Handle

NI-5-117-31

Scalpel Handle
21.5 cm



Scalpel Handle

NI-5-118-35

Scalpel Handle
21cm



Scalpel Handle

NI-5-119-07

Scalpel Handle
16 cm



Scalpel Handle

NI-5-120-71

Scalpel Handle
12.5 cm



Scalpel Handle

NI-5-121-03

Scalpel Handle
15.5 cm



Amputation Knife

NI-5-127-16

Amputation Knife
29 cm



Amputation Knife

NI-5-128-19

Amputation Knife
32.5 cm



Catlin

NI-5-129-16

Interosseous Knife with hollow handle
29 cm



Resection Knife

NI-5-130-06

Resection Knife
18 cm



Langenbeck

NI-5-131-05

Resection Knife
18 cm



Langenbeck

NI-5-132-05

Langenbeck
18 cm



Razor Knife

NI-5-133-00

Razor Knife hollow blades on both sides cutting length 75mm



Schink

NI-5-134-00

Dermatome complete with 2 skin fixing plates and one blade
31 cm



Schink

NI-5-135-01

Spare Blade spare blade for KE-05-134-00

&nb



Schink

NI-5-136-02

Skin Fixing Plate for KE-05-134-00



Standard BL / BL Straight

NI-5-201-13

Operating Scissor Special Price:
\$1.25

12 cm, 13cm, 14.5 cm , 16.5 cm, 18.5 cm ,
20.5 cm



Standard SH / BL STR

NI-5-202-13

Operating Scissors

12 cm, 13cm, 14.5 cm , 16.5 cm, 18.5 cm ,
20.5 cm



Standard SH / SH STR

NI-5-204-13

Operating Scissors

12 cm, 13cm, 14.5 cm , 16.5 cm



Standard BL / BL Curved

NI-5-205-13

Operating Scissors

12 cm, 13cm, 14.5 cm , 16.5 cm, 18.5 cm ,
20.5 cm

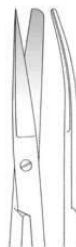

Standard SH / BL Curved

NI-5-206-13

Operating Scissors

12 cm, 13cm, 14.5 cm , 16.5 cm, 18.5 cm ,
20.5 cm



Standard SH / SH Curved

NI-5-207-13

Operating Scissors

12 cm, 13cm, 14.5 cm , 16.5 cm



Standard BL / BL Curved

NI-5-208-14

Operating Scissors delicate

14.5 cm



Incision Scissor

NI-5-209-14

Operating Scissor

14.5 cm



Deaver

NI-5-210-14

Operating Scissors



Mayo

NI-5-211-15

Dissecting Scissors

14.5 cm , 15 cm, 17 cm , 23.5 cm



Mayo

NI-5-212-23

Dissecting Scissors

23 cm , 22.5 cm, 28 cm



Mayo-Harrington

NI-5-213-22

Dissecting Scissors

23 cm , 22.5 cm, 28 cm

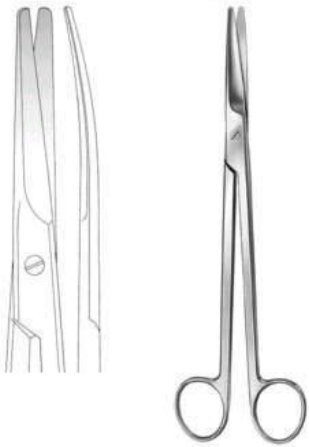

Mayo-Harrington

NI-5-214-22

Dissecting Scissors cur.
22.5 cm, 23 cm , 28 cm

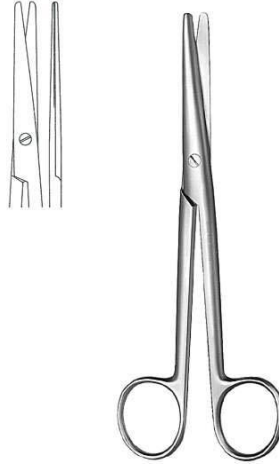

Mayo-Stille

NI-5-215-17

Dissecting Scissors str.
15 cm, 17 cm

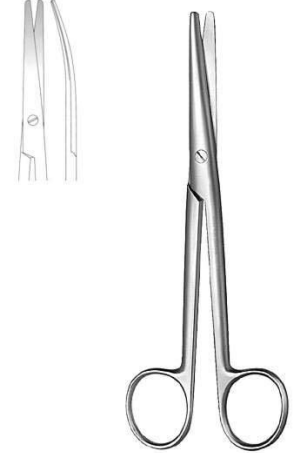

Mayo-Stille

NI-5-216-15

Dissecting Scissors cur.
15 cm, 17 cm

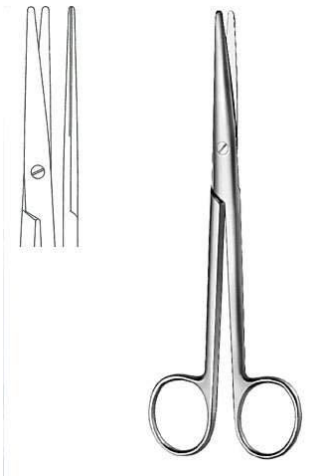

Mayo-Stille

NI-5-217-19

16 cm, 19.5 cm , 21.5 cm

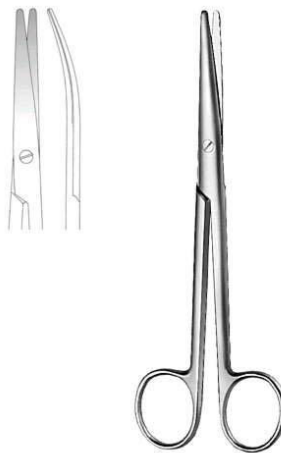

Mayo-Stille

NI-5-218-16

Dissecting Scissors cur.
16 cm, 19.5 cm , 21.5 cm



Mayo-Noble

NI-5-219-17

Gynecological Scissors
16.5 cm



Sims

NI-5-220-23

Gynecological Scissors str.

20cm, 23 cm



Sims

NI-5-221-20

Gynecological Scissors cur.

20cm, 23 cm



Kelly

NI-5-222-16

Operating Scissors

16 cm



Doyen

NI-5-223-17

Gynecological Scissors

18.5 cm



Sims-Siebold

NI-5-224-24

24.5 cm



Sims-Siebold

NI-5-225-24

Gynecological Scissors

24.5 cm



Wertheim

NI-5-226-23

Gynecological Scissors

20cm, 23 cm



Metzenbaum

NI-5-227-11

Dissecting Scissors

11



Metzenbaum

NI-5-228-14

Dissecting Scissors

14.5 cm



Metzenbaum

NI-5-229-15

Dissecting Scissors

15.5 cm



Metzenbaum-Nelson

NI-5-230-20

Dissecting Scissors

18 cm, 20.5 cm, 23 cm , 26 cm, 28.5 cm,
31 cm



Metzenbaum-Nelson

NI-5-231-20

Dissecting Scissors

18 cm, 20.5 cm



Metzenbaum-Nelson

NI-5-232-20

Dissecting Scissors

18 cm, 20.5 cm, 23 cm, 26 cm, 28.5 cm,
31 cm



Metzenbaum

NI-5-233-14

Dissecting Scissors toothed

14.5 cm



Nerve Operating Scissor

NI-5-234-15

Dissecting Scissors

15.5 cm



Gorney

NI-5-235-19

Face-lift Scissors str.

12.5 cm, 19.5 cm



Gorney

NI-5-236-19

Face-lift Scissors cur.

19.5 cm



Aston

NI-5-237-17

Face-lift Scissors

17 cm



Lexer

NI-5-238-16

Dissecting Scissors

16 cm



Cinelli

NI-5-239-14

Nasal Scissors

11.5cm, 14 cm



Thorek

NI-5-240-19

Dissecting Scissors

18.5 cm



Lexer-Baby

NI-5-241-10

Dissecting Scissors

10 cm



Lexer-Fino

NI-5-242-16

Delicate Dissecting Scissors
slender pattern

16.5 cm



Metzenbaum-Fino

NI-5-243-14

Delicate Dissecting Scissors
slender pattern

14.5 cm



Metzenbaum-Fino

NI-5-244-14

Delicate Dissecting Scissors

14.5 cm



Metzenbaum-Fino

NI-5-245-14

Delicate Dissecting Scissors

<
14.5 cm



Metzenbaum-Fino

NI-5-246-14

Delicate Dissecting Scissors

14.5 cm

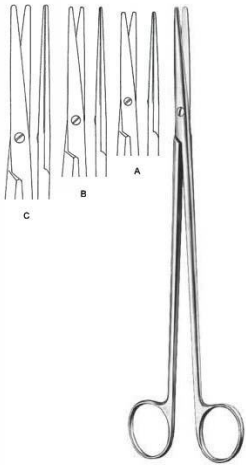

Metzenbaum-Fino

NI-5-247-18

Delicate Dissecting Scissors
slender pattern

18 cm, 20cm, 23 cm

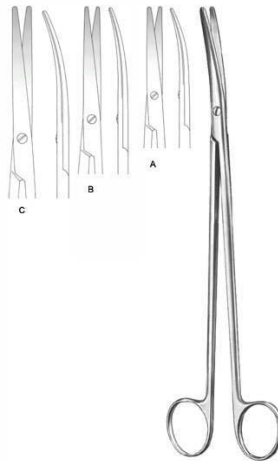

Metzenbaum-Fino

NI-5-248-18

Delicate Dissecting Scissors
slender pattern

18 cm, 20cm, 23 cm

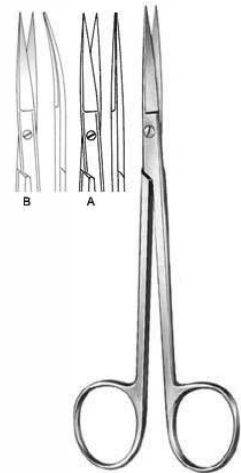

Sanvenero

NI-5-250-14

Operating Scissors

14 cm

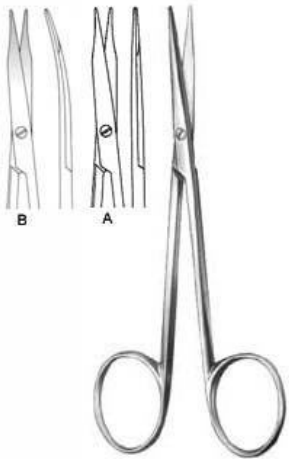

Fine Operating Scissors

NI-5-251-11

Fine Operating Scissors
11.5cm

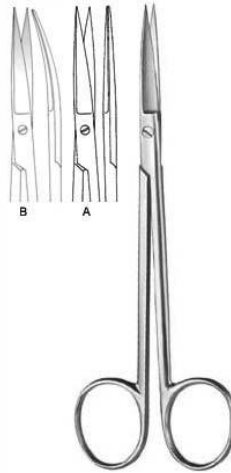

Joseph

NI-5-252-14

Operating Scissors
14.5 cm

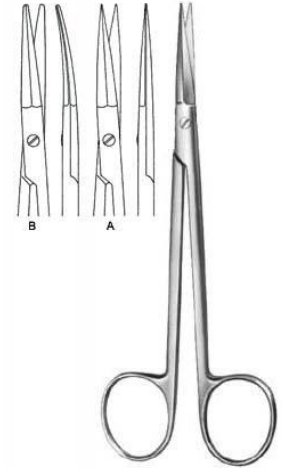

Peck-Joseph

NI-5-253-14

Face-lift Scissors
14.5 cm

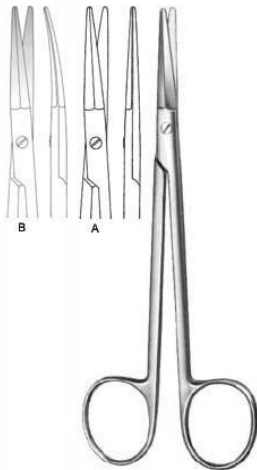

Peck-Joseph

NI-5-254-14

Face-lift Scissors
14.5 cm



Shea Vein Graft

NI-5-255-12

Dissecting Scissors
12 cm

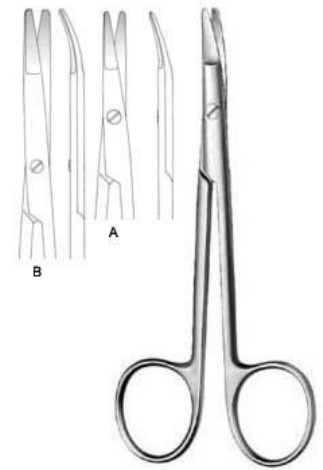

Kilner

NI-5-256-12

Dissecting Scissors
12 cm, 15 cm

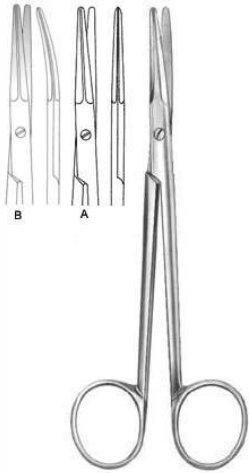

Dissecting Scissors

NI-5-257-14

Dissecting Scissors
14.5 cm

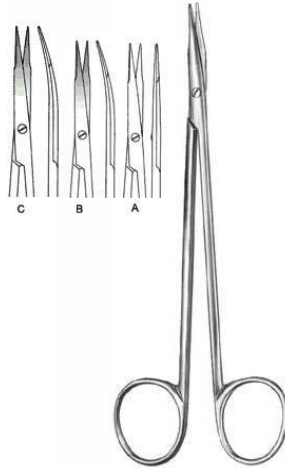

Reynolds

NI-5-258-15

Dissecting Scissors
15.5 cm, 18 cm



Jameson

NI-5-259-14

Dissecting Scissors
15.5 cm



Jameson

NI-5-260-14

Dissecting Scissors
15.5 cm



Vascular Scissors

NI-5-261-19

Vascular Scissors
19 cm

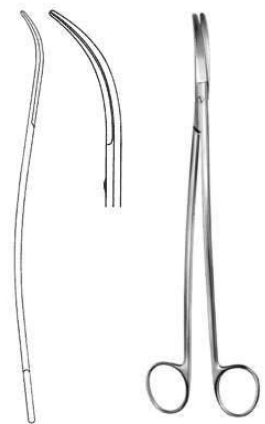

Vascular Scissors

NI-5-262-24

Vascular Scissors
19 cm , 25.5 cm

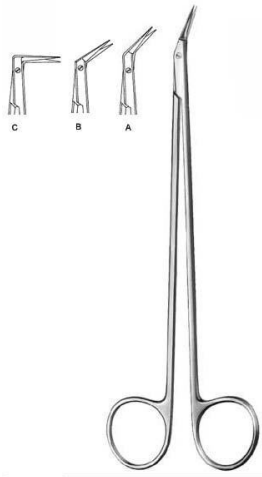

Diethrich

NI-5-263-25

ascular Scissors

17.5 cm, 18.5 cm , 19 cm

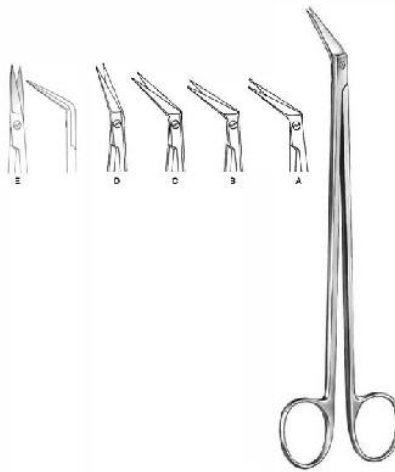

DeBakey

NI-5-264-45

ascular Scissors

16 cm, 16.5 cm

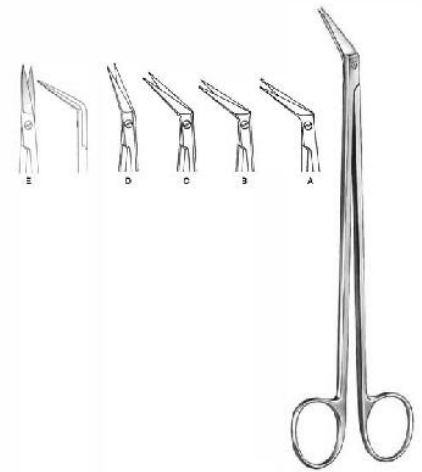

Potts-Smith

NI-5-265-19

Vascular Scissors

18 cm, 18.5 cm , 19 cm



Coronary Scissors

NI-5-267-45

Cardiovascular Surgery Scissors

18 cm



Coronary Scissors

NI-5-267-45

Cardiovascular Surgery Scissors

18 cm



Coronary Scissors

NI-5-268-60

Cardiovascular Surgery Scissor

18 cm



Coronary Scissors

NI-5-269-90

Cardiovascular Surgery Scissor

18 cm



Coronary Scissors

NI-5-272-25

Cardiovascular Surgery Scissor

18 cm



Coronary Scissors

NI-5-270-00

Cardiovascular Surgery Scissor

18 cm



Coronary Scissors

NI-5-273-45

Cardiovascular Surgery Scissor

18 cm



Coronary Scissors

NI-5-271-00

Cardiovascular Surgery Scissor

18 cm



Coronary Scissors

NI-5-274-90

Cardiovascular Surgery Scissor

18 cm



Schmieden-Taylor

NI-5-275-17

Dura Scissors

15 cm



Strully

NI-5-276-22

Neurosurgical Scissors

22.5 cm



Toennis-Adson

NI-5-277-17

Dissecting Scissors

17.5 cm



Good

NI-5-279-19

Tonsil Scissors

19.5 cm



Fomon

NI-5-282-15

Nasal Scissors

15 cm



Cottle

NI-5-283-16

Nasal Scissors

16 cm



Heymann

NI-5-284-18

Nasal Scissors
18.5 cm



Heymann

NI-5-285-18

Nasal Scissors
18.5 cm



Converse

NI-5-286-11

Nasal Scissors blunt & sharp
10.5 cm



Waldmann

NI-5-287-18

Episiotomy Scissors
18 cm



Braun-Stadler

NI-5-268-60

Episiotomy Scissors
14.5 cm



Braun-Stadler

NI-5-289-22

Episiotomy Scissors
22cm



McIndoe
NI-5-405-12

Dressing Forceps

15 cm



Waugh
NI-5-408-20

Dressing Forceps

20cm



Semken
NI-5-409-12

Dressing Forceps

12.5 cm, 15 cm



Taylor
NI-5-410-17

Dressing Forceps

12.5 cm, 15 cm



Taylor
NI-5-411-17

Dressing Forceps

17 cm



Taylor
NI-5-412-17

Dressing Forceps

18.5 cm



Dressing Forceps

NI-5-413-06

Dressing Forceps
15.5 cm



Gerald

NI-5-414-18

Dressing Forceps

15.5 cm



Cushing

NI-5-415-17

Dressing Forceps

17.5 cm



Potts-Smith

NI-5-416-18

Dressing Forceps

18 cm, 21cm, 24.5 cm



Bonney

NI-5-417-17

Dissecting Forceps

17.5 cm



Gerald

NI-5-418-17

17.5 cm



Gillies

NI-5-419-15

Dissecting Forceps

15.5 cm



McIndoe

NI-5-420-15

Dressing Forceps

15 cm



Semken

NI-5-421-16

Dissecting Forceps

15.5 cm, 17.5 cm



Adson-Brown

NI-5-422-12

Dissecting Forceps

12 cm



Adson

NI-5-423-12

Dissecting Forceps

12 cm, 15 cm



Adson

NI-5-424-12

Dressing Forceps

12 cm, 15 cm



Cushing

NI-5-425-17

Dressing Forceps

17.5 cm



Potts-Smith

NI-5-428-15

Dressing Forceps

16 cm, 18.5 cm, 20cm, 23 cm, 25 cm



Cushing

NI-5-426-18

Dressing Forceps

17 cm



Oehler

NI-5-429-14

Dissecting Forceps

14.5 cm, 16 cm, 18 cm, 20cm, 25 cm



Cushing-Taylor

NI-5-427-18

Dressing Forceps

18.5 cm



Wangensteen

NI-5-430-15

Dressing Forceps

15 cm, 23 cm



DeBakey

NI-5-421-16

Atraumatic Dressing Forceps

16 cm, 20cm, 24.5 cm



DeBakey

NI-5-432-16

Atraumatic Dressing Forceps

16 cm, 20cm, 24 cm

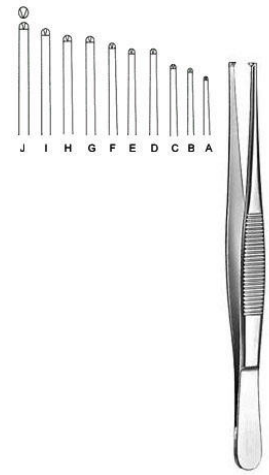

Dissecting Forceps

NI-5-433-10

Dissecting Forceps

10.5 cm , 11.5cm, 13 cm , 14.5 cm , 16 cm,
18 cm, 20cm, 23 cm , 25 cm , 30.5 cm

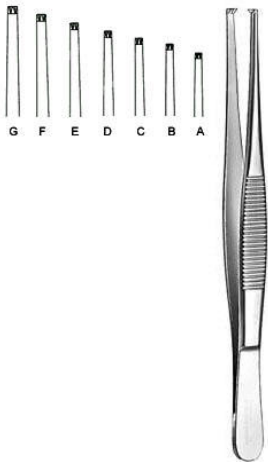

Dissecting Forceps

NI-5-434-11

Dissecting Forceps

12 cm, 13 cm , 14.5 cm , 15.5 cm, 18 cm,
20cm, 24.5 cm



Dissecting Forceps

NI-5-435-14

Dissecting Forceps

14.5 cm , 16 cm



Dissecting Forceps

NI-5-436-14

Dissecting Forceps

14.5 cm , 16 cm



Dissecting Forceps

NI-5-437-13

Dissecting Forceps

13 cm , 14.5 cm , 16 cm, 20cm



Dissecting Forceps

NI-5-438-13

Dissecting Forceps

13 cm , 14.5 cm



Stille

NI-5-439-15

Dissecting Forceps

15 cm



Stille

NI-5-440-15

Dissecting Forceps

15 cm



Stone

NI-5-441-15

Dissecting Forceps

15 cm



Lerche

NI-5-442-15

Dissecting Forceps

15 cm

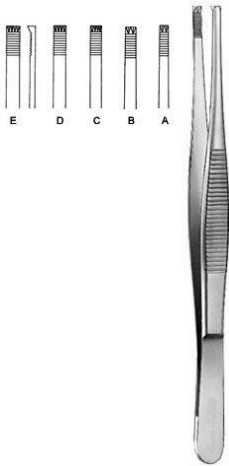

Adlerkreutz

NI-5-443-15

Dissecting Forceps

15.5 cm, 20.5 cm, 16 cm, 20cm, 25 cm

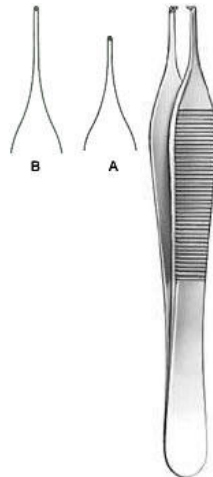

Adson

NI-5-444-12

Dissecting Forceps

12 cm, 15 cm



Gillies

NI-5-445-15

Dissecting Forceps

15.5 cm



Waugh

NI-5-446-20

Dissecting Forceps

20.5 cm



Semken

NI-5-447-12

Dissecting Forceps

12.5 cm, 15 cm



Taylor

NI-5-448-17

Dissecting Forceps

17.5 cm



Splinter Forceps Smooth Jaw

NI-5-467-12

Splinter Forceps smooth jaw
12.5 cm



Splinter Forceps Smooth Jaw

NI-5-468-12

Splinter Forceps smooth jaw
12.5 cm



Splinter Forceps

NI-5-469-12

Splinter Forceps
12.5 cm



Splinter Forceps

NI-5-470-12

Splinter Forceps
12.5 cm



Micro Tying Forceps

NI-5-471-16

Micro Tying Forceps
15.5 cm



Microscopic Forceps Super Light, Blunt

NI-5-472-10

Microscopic Forceps super light, blunt
10 cm



Microscopic Forceps

NI-5-473-10

Microscopic Forceps
10 cm



Shaaf

NI-5-474-09

Splinter Forceps
9.5 cm



Littauer

NI-5-475-08

Cilia Forceps
8.5 cm



Cilia Forceps

NI-5-476-09

Cilia Forceps
8.5 cm



Douglas

NI-5-477-09

Cilia Forceps
9 cm



Douglas

NI-5-478-09

Cilia Forceps
9 cm



Beer

NI-5-479-09

Cilia Forceps

9 cm



Phaneuf

NI-5-501-21

Hysterectomy Forceps
20.5 cm



Wertheim-Cullen

NI-5-502-21

Vaginal Clamp
21 cm

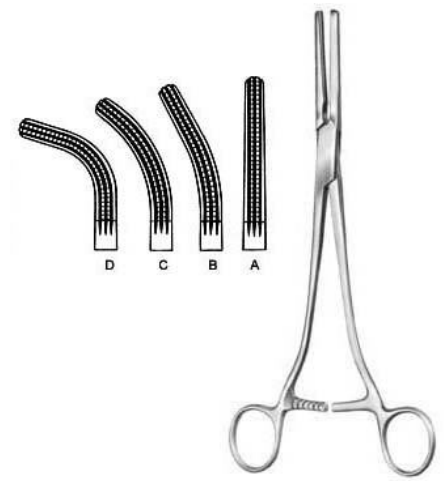

Rogers

NI-5-503-10

Hysterectomy Forceps
21.5 cm Fig. 1, 21 cm Fig. 2, 20.5 cm Fig. 3,
20 cm Fig. 4



Moynihan

NI-5-504-23

Hysterectomy Forceps
23 cm



Moynihan

NI-5-505-24

Hysterectomy Forceps
23.5 cm



Wertheim

NI-5-506-25

Hysterectomy Forceps
26 cm

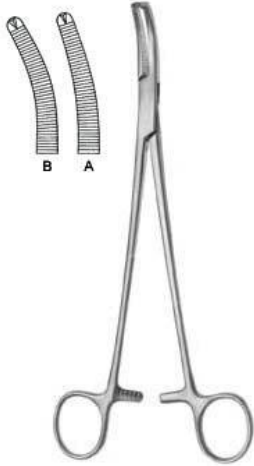

Wertheim

NI-5-507-22

Hysterectomy Forceps
22.5 cm



Mikulicz, Baby

NI-5-508-14

Peritoneum Forceps
14.5 cm



Mikulicz

NI-5-509-18

Peritoneum Forceps
20.5 cm



Mikulicz

NI-5-510-20

Peritoneum Forceps
18.5 cm



Mikulicz

NI-5-511-20

Peritoneum Forceps
20cm



Mikulicz

NI-5-512-21

Peritoneum Forceps
20.5 cm



Faure

NI-5-513-20

Peritoneum Forceps

21 cm

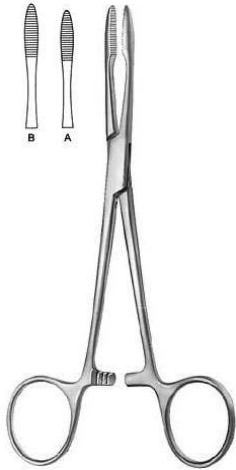

Pean

NI-5-601-14

Haemostatic Forceps

14.5 cm , 16 cm

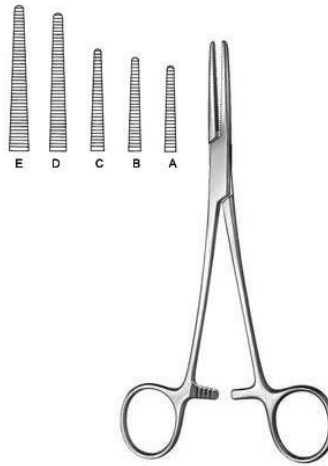

Spencer-Wells

NI-5-602-13

Haemostatic Forceps

13 cm , 14 cm, 15.5 cm, 18.5 cm , 20 cm

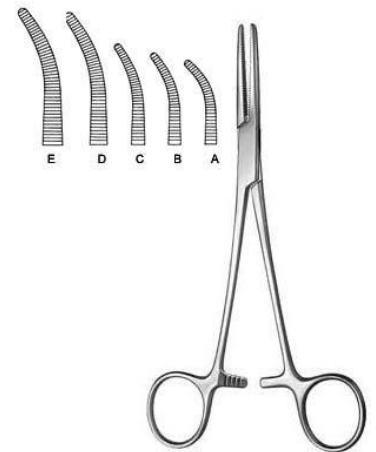

Spencer-Wells

NI-5-603-13

Haemostatic Forceps

13 cm , 14 cm, 15 cm, 18 cm, 20 cm



Chaput

NI-5-604-13

Haemostatic Forceps

12.5 cm



Tuffier

NI-5-605-13

Haemostatic Forceps

12.5 cm

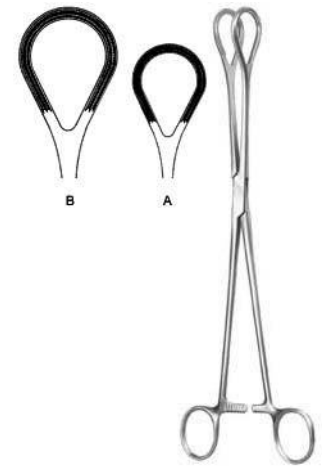

Grasping Forceps

NI-5-606-25

Organ Grasping Forceps



Collin

NI-5-607-14

Organ Grasping Forceps

12.5 cm, 21 cm



Collin

NI-5-608-17

Tumor Grasping Forceps

17 cm



Pennington

NI-5-609-15

Haemostatic Forceps

15.5 cm



Pratt

NI-5-610-15

Haemostatic Forceps

15 cm



Martel-Rees

NI-5-611-14

Face-lift Forceps

13.5 cm



Ligature Forceps

NI-5-612-12

Ligature Forceps

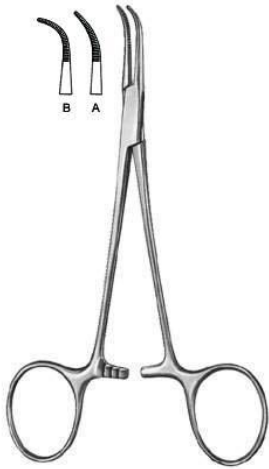

Mixer-Baby

NI-5-613-01

Dissecting and Ligature Forceps

13 cm , 13.5 cm

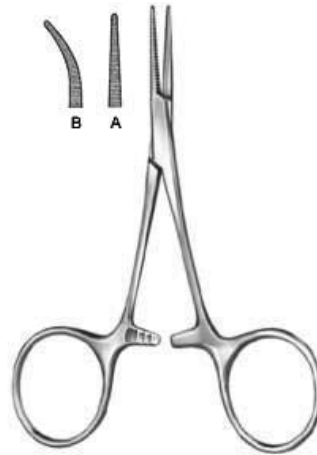

Hartmann

NI-5-614-10

Haemostatic Forceps

9.5 cm, 10 cm



Ligature Forceps

NI-5-615-12

Ligature Forceps

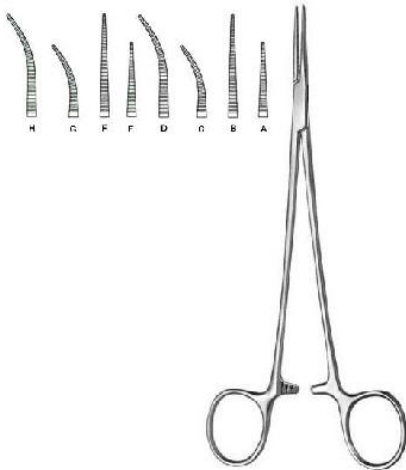

Halsted-Mosquito

NI-5-616-18

Haemostatic Forceps

12.5 cm, 14 cm, 14.5 cm

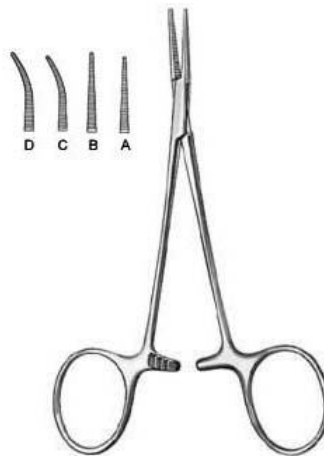

Mikro-Mosquito

NI-5-617-10

Haemostatic Forceps

9.5 cm, 10 cm , 11.5 cm, 12 cm

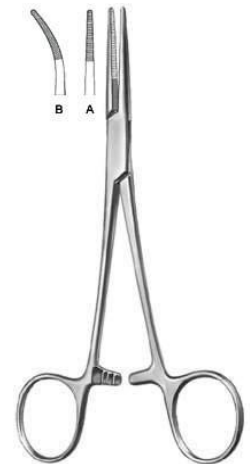

Providence-Hospital

NI-5-618-14

Haemostatic Forceps

14 cm



Leriche

NI-5-619-15

Haemostatic Forceps

15 cm, 15.5 cm

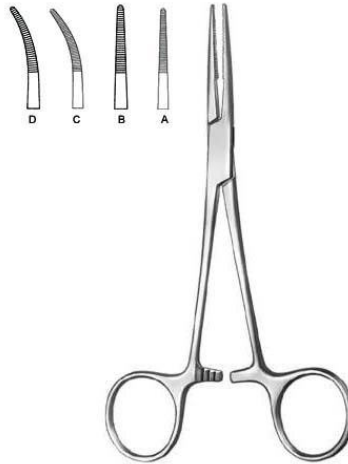

Kelly

NI-5-620-14

Haemostatic Forceps

14 cm, 14.5 cm

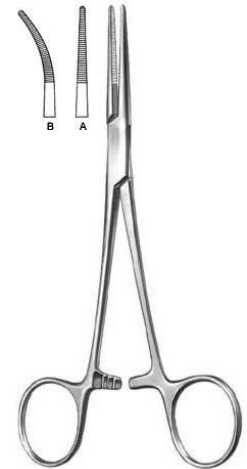

Kelly-Rankin

NI-5-621-16

Haemostatic Forceps

15.5 cm, 16 cm



Overholt-Baby

NI-5-622-14

Dissecting and Ligature Forceps

14 cm, 14.5 cm



Crile

NI-5-623-14

Haemostatic Forceps

14 cm, 14.5 cm



Crile-Rankin

NI-5-624-16

Haemostatic Forceps

16 cm, 16.5 cm

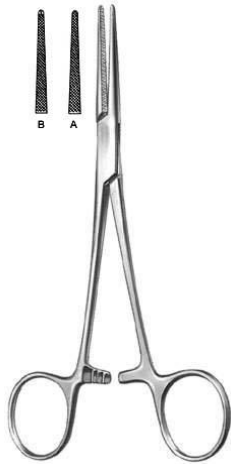

Lovelace

NI-5-625-15

Haemostatic Forceps
16 cm



Dandy-Mosquito

NI-5-626-12

Haemostatic Forceps
12 cm

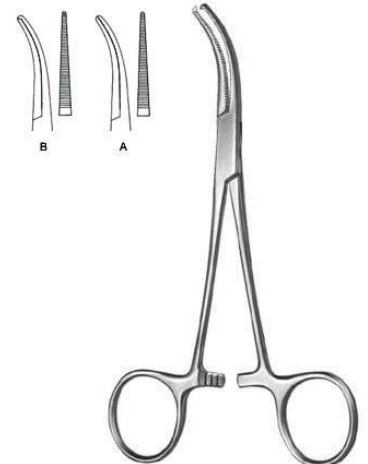

Dandy

NI-5-627-14

Haemostatic Forceps
14 cm, 14.5 cm



Schmidt

NI-5-628-18

Dissecting and Ligature Forceps
18.5 cm, 19 cm



Adson

NI-5-629-18

Dissecting and Ligature Forceps
18.5 cm, 19 cm



Martin-Fuchsig

NI-5-630-20

Dissecting and Ligature Forceps
20.5 cm

Haemostatic Forceps

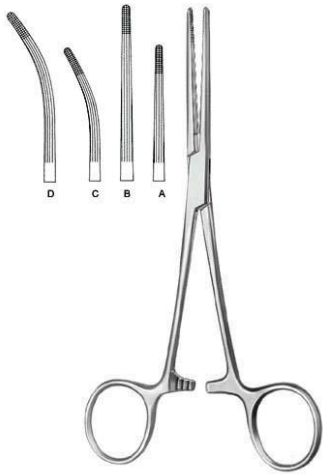

Rochester-Carmalt

NI-5-631-16

Haemostatic Forceps
16.5 cm, 17 cm, 20 cm, 20.5 cm

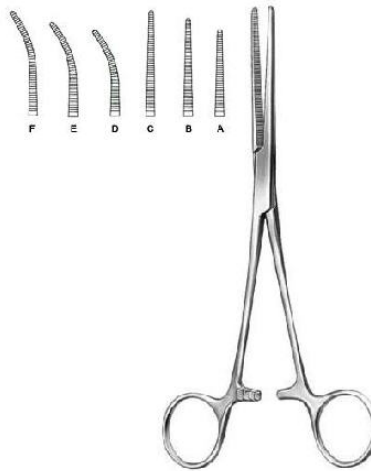

Pean

NI-5-632-13

Haemostatic Forceps
13 cm, 13.5 cm, 14 cm, 14.5 cm, 16.5 cm, 17 cm

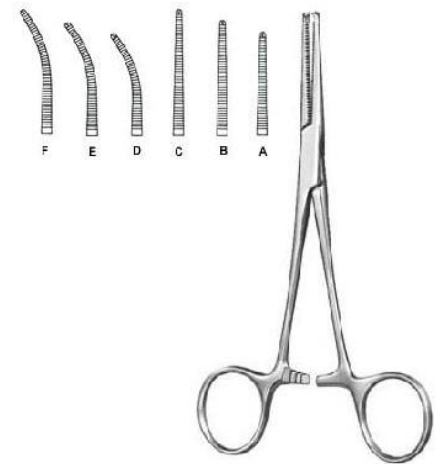

Kocher-Nippon

NI-5-633-14

Haemostatic Forceps
14.5 cm, 16 cm, 16.5 cm, 18 cm, 18 cm

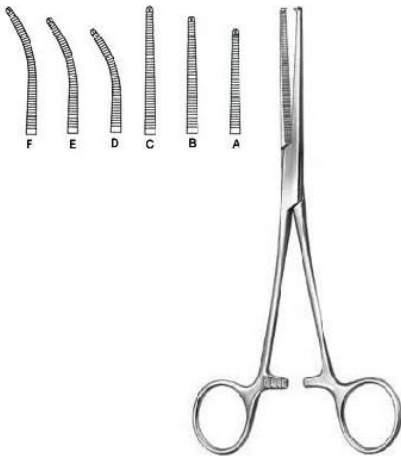

Kocher

NI-5-635-13

Haemostatic Forceps
13 cm, 14 cm, 16 cm

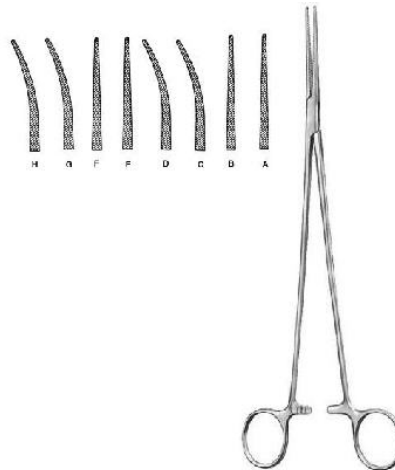

Bengolea

NI-5-636-20

Haemostatic Forceps
21 cm, 21.5 cm, 26 cm

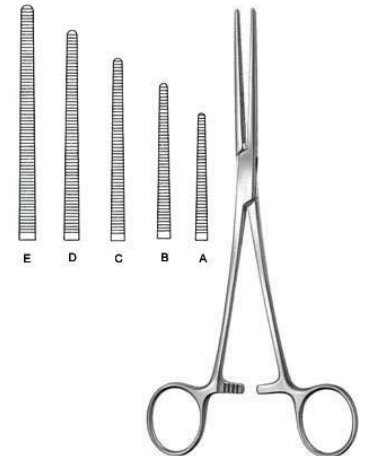

Pean (Rochester)

NI-5-637-14

Haemostatic Forceps
14 cm, 14.5 cm, 16 cm, 16.5 cm, 18.5 cm, 20.5 cm, 22.5 cm, 24.5 cm, 26 cm, 30.5 cm

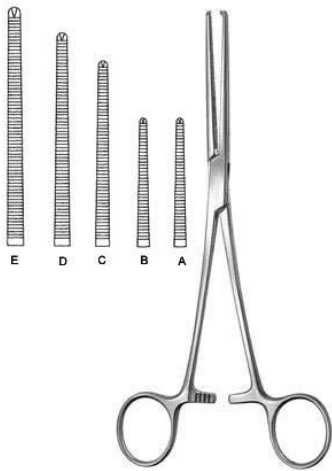

Kocher (Ochsner)

NI-5-638-14

Haemostatic Forceps

14.5 cm , 16.5 cm , 18.5 cm , 20.5 cm , 22.5 cm , 24.5 cm , 26 cm , 30.5 cm

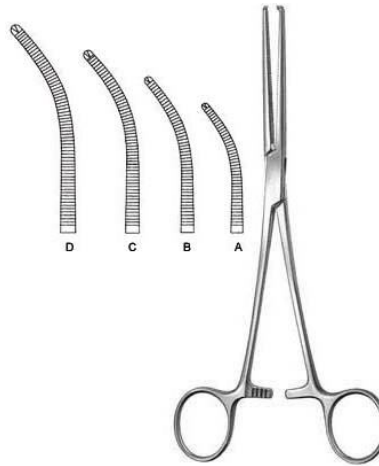

Kocher (Ochsner)

NI-5-639-14

Haemostatic Forceps

14 cm , 16 cm , 18 cm , 20 cm , 22 cm , 24 cm , 25.5 cm , 30 cm

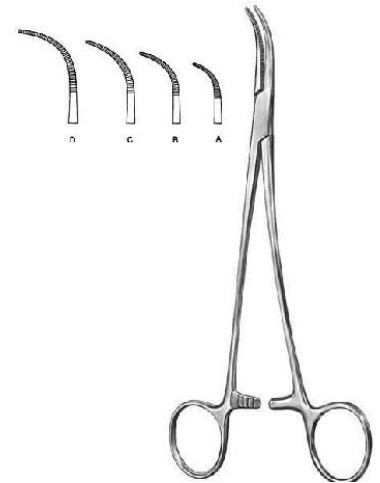

Overholt-Martin

NI-5-640-01

Dissecting and Ligature Forceps

18.5 cm Fig. 1 , 20.5 cm Fig. 2, 21 cm Fig. 3, 21.5 cm Fig. 4, 24.5 cm Fig. 5



Mixer-Baby

NI-5-641-18

Dissecting and Ligature Forceps

18.5 cm



Adson-Baby

NI-5-642-14

Dissecting and Ligature Forceps

14.5 cm , 18 cm

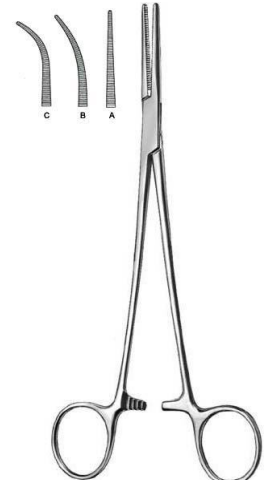

Heiss

NI-5-643-20

Dissecting and Ligature Forceps

20 cm , 20.5 cm , 21 cm



Overholt-Mixter

NI-5-644-21

Dissecting and Ligature Forceps
21.5 cm

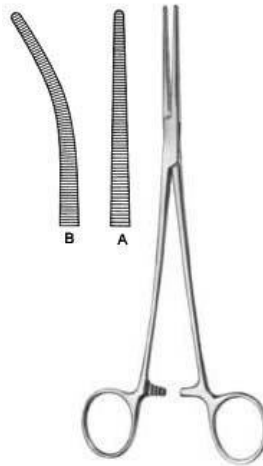

Roberts

NI-5-645-22

Dissecting and Ligature Forceps
21.5 cm, 22.5 cm

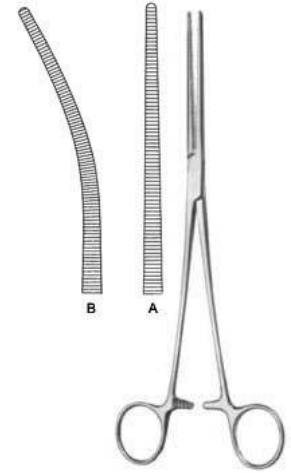

Sarot

NI-5-646-24

Dissecting and Ligature Forceps
24.5 cm, 25 cm

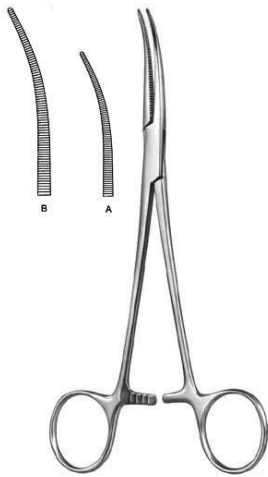

Crafoord

NI-647-18

Dissecting and Ligature Forceps
18 cm, 24.5 cm

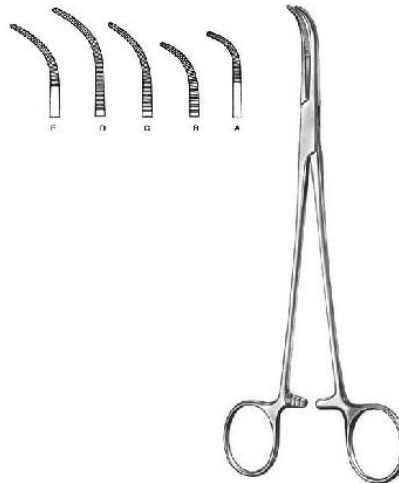

Overholt-Geissendorfer

NI-5-648-01

Dissecting and Ligature Forceps
20.5 cm Fig. 1 , 20 cm Fig. 2 , 21.5 cm Fig. 3 , 22 cm Fig. 4, 21.5 cm Fig. 5, 22 cm Fig. 6 , 27 cm Fig. 1 , 26.5 cm Fig. 2 , 27.5 cm Fig. 3 , 28 cm Fig. 4

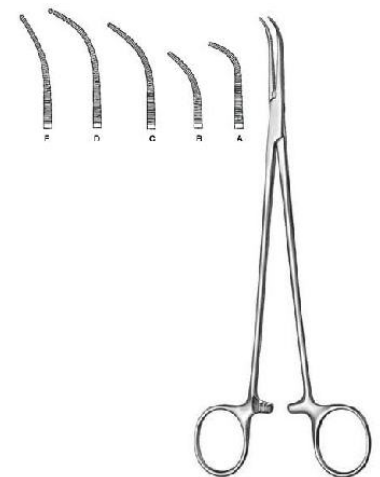

Overholt-Fino

NI-5-649-00

Dissecting and Ligature Forceps
21 cm, 21.5 cm, 22 cm, 22.5 cm, 23 cm

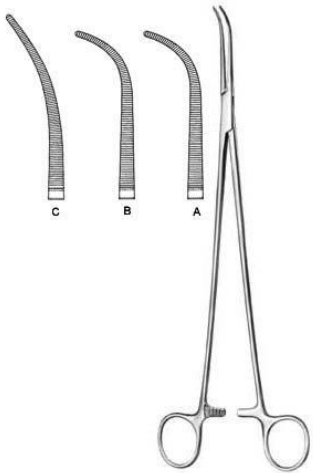

Overholt

NI-5-650-00

Dissecting and Ligature Forceps
29.5 cm, 30 cm



Overholt-Mini

NI-5-651-01

Dissecting and Ligature Forceps
15 cm, 20 cm

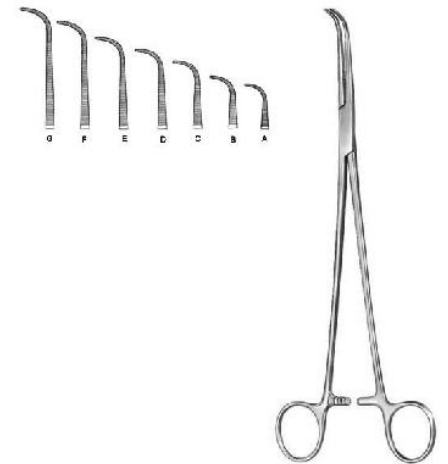

Gemini

NI-5-652-13

Dissecting and Ligature Forceps
13 cm , 16 cm, 18 cm, 21 cm, 23 cm , 25 cm , 28 cm

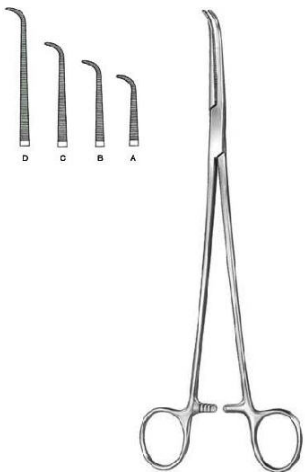

Mini-Gemini

NI-5-653-18

Dissecting and Ligature Forceps
18 cm, 22.5 cm, 25 cm , 28.5 cm

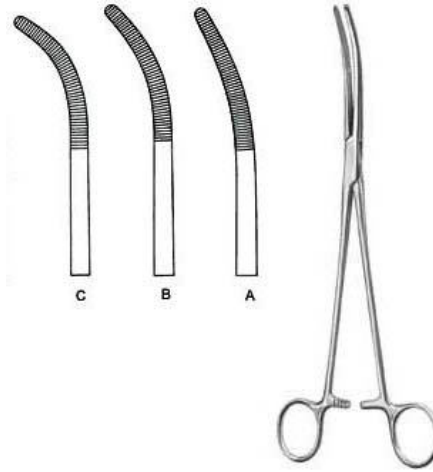

Rumel

NI-5-654-01

Dissecting and Ligature Forceps
24 cm Fig. 1 , 23.5 cm Fig. 2 , 23 cm Fig. 3,
24 cm Fig. 4 , 23.5 cm Fig. 5

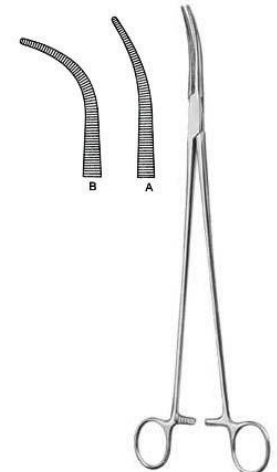

Zenker

NI-5-655-01

Dissecting and Ligature Forceps
28.5 cm, 29.5 cm



Mixer-Baby

NI-5-656-14

Dissecting and Ligature Forceps
13.5 cm

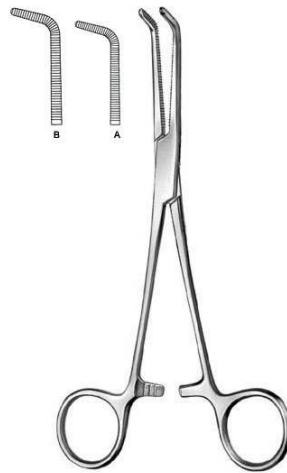

Mixer

NI-5-657-15

Dissecting and Ligature Forceps
16 cm, 18 cm



Mixer-O Shaugnessy

NI-5-658-19

Dissecting and Ligature Forceps
18 cm



Mixer

NI-5-659-22

Dissecting and Ligature Forceps
22.5 cm



Mixer

NI-5-660-23

Dissecting and Ligature Forceps
23 cm

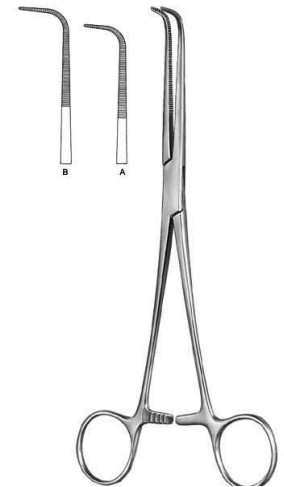

Wickstrom

NI-5-661-21

Dissecting and Ligature Forceps
21 cm, 24.5 cm



Mixer

NI-5-662-22

Dissecting and Ligature Forceps
22.5 cm, 26 cm, 28 cm



Mc Quigg-Mixer

NI-5-663-22

Dissecting and Ligature Forceps
23.5 cm



Lower

NI-5-664-18

Dissecting and Ligature Forceps
18.5 cm

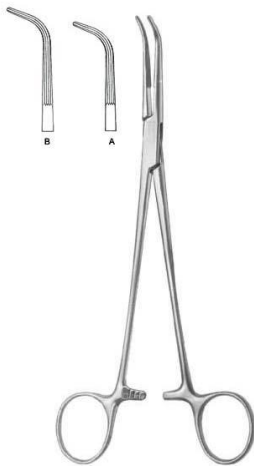

Lahey

NI-5-665-19

Bile Duct Clamp
19.5 cm, 22.5 cm



Finochietto

NI-5-666-24

Dissecting and Ligature Forceps
24 cm

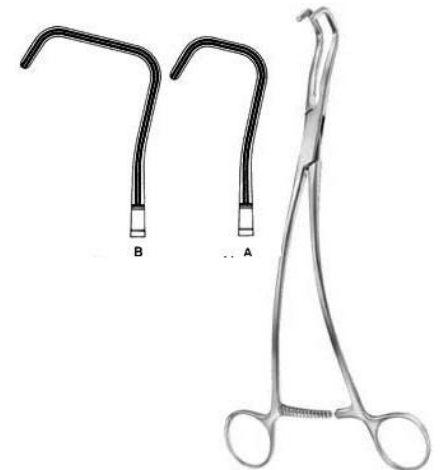

Uro-Tangential

NI-5-667-01

Tangential Forceps
25 cm, 27 cm

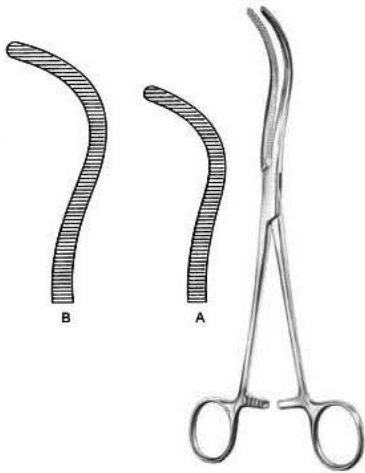

Guyon

NI-5-668-20

Kidney Pedicle Clamp
23 cm , 24 cm



Guyon

NI-5-669-23

Kidney Pedicle Clamp
19.5 cm , 21.5 cm, 24 cm



Desjardins

NI-5-670-21

Bile Duct Clamp
21 cm

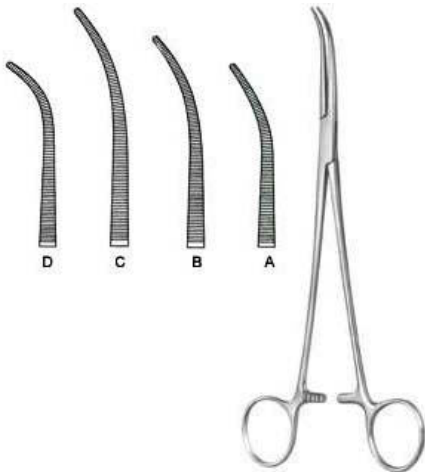

Kelly

NI-5-671-19

Dissecting and Ligature Forceps
19.5 cm Fig. 1 , 22.5 cm Fig. 1 , 24.5 cm
Fig. 1 , 19 cm Fig. 2 , 22 cm Fig. 2 , 24 cm
Fig. 2 , 18.5 cm Fig. 3 , 23.5 cm Fig. 3 , 21.5
cm Fig. 3



Lawrence

NI-5-672-28

Dissecting and Ligature Forceps
28 cm



Meeker

NI-5-673-28

Dissecting and Ligature Forceps
28 cm



Negus

NI-5-674-19

Haemostatic Forceps

19.5 cm Fig. 1 , 20 cm Fig. 2



Schaedel

NI-5-701-09

Towel Clamp sharp
9 cm



Jones

NI-5-702-05

Towel Clamp sharp
5.5 cm, 8.5 cm



Jones-Martin

NI-5-703-09

Towel Clamp sharp
8.5 cm



Backhaus

NI-5-705-11

Towel Clamp
11.5 cm



Backhaus

NI-5-706-08

Towel Clamp
9 cm, 11.5 cm, 13 cm, 16 cm



Peers-Bertram Modif.

NI-5-707-15

Towel Clamp wide jaw for tube fixation
15.5 cm



R?Der

NI-5-708-13

Towel Clamp
13.5 cm

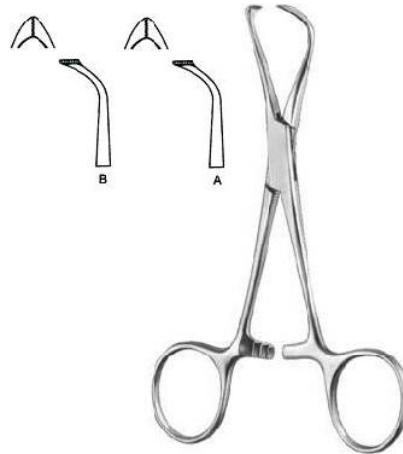

Lorna

NI-5-709-10

Towel Clamp fine serrated, wide jaw
9.5 cm, 13 cm



Bernhard

NI-5-710-16

Towel Clamp
16.5 cm

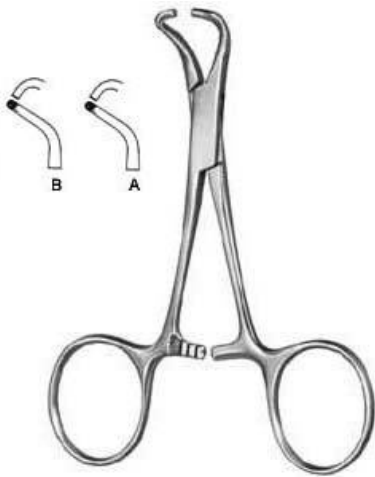

Tohoku

NI-5-711-10

Towel Clamp
10.5 cm blunt, 13.5 cm blunt, 14.5 cm

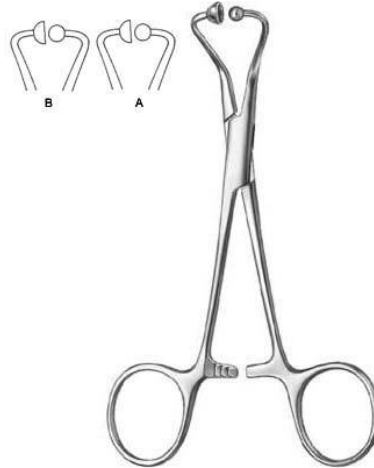

Towel Clamp For Paper Clothes

NI-5-712-11

Towel Clamp for paper clothes
11.5 cm, 14 cm



Lane

NI-5-713-20

Lane
19.5 cm



Tube Holder For Fixation Of Six Tubes

NI-5-714-06

Tube Holder for fixation of six tubes



Tubing Clamp Extra Long Ratchet

NI-5-715-14

Tubing Clamp extra long ratchet
14 cm



Tubing Clamp

NI-5-716-16

Tubing Clamp
16.5 cm

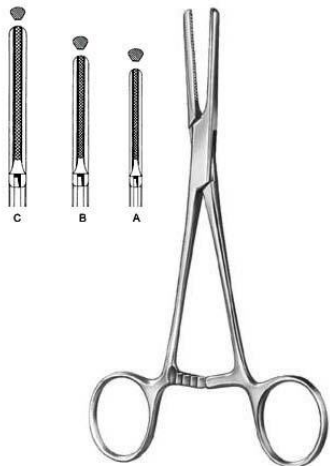

Tubing Clamp

NI-5-717-15

Tubing Clamp
15.5 cm, 19 cm, 20.5 cm

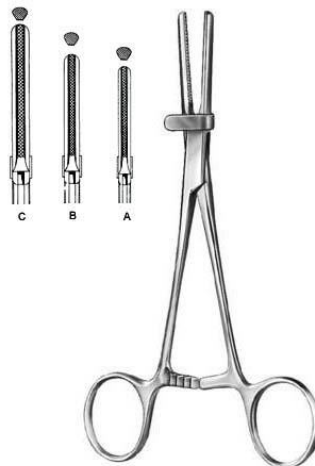

Tubing Clamp With Safety Guard

NI-5-718-15

Tubing Clamp with safety guard
15.5 cm, 19 cm, 20.5 cm

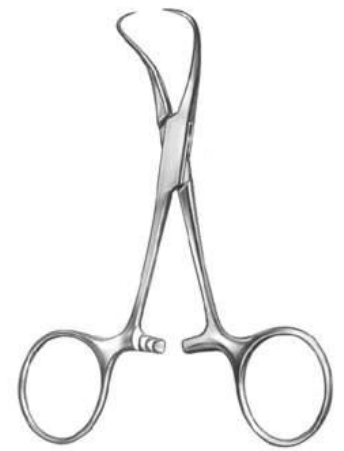

Backhaus

NI-5-704-11

Towel Clamp
11.5 cm, 13 cm

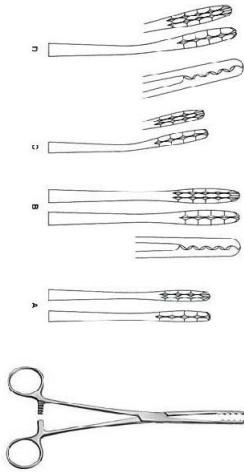

Ulrich

NI-5-801-22

Dressing Forceps
21.5 cm, 26.5 cm

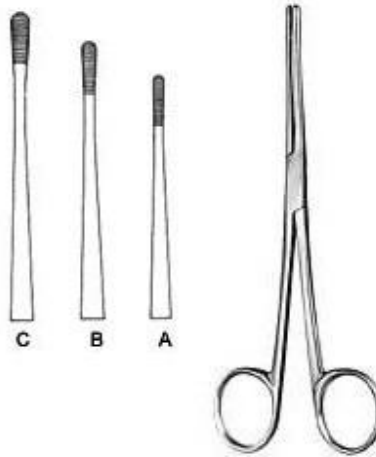

Lister

NI-5-802-13

Sinus Forceps
13 cm, 16 cm, 18 cm



Martin

NI-5-803-17

Dressing Forceps
17.5 cm, 17 cm

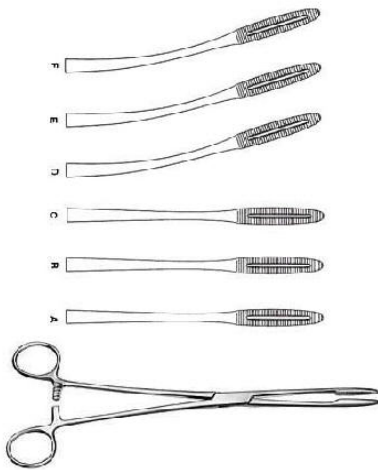

Gross-Maier

NI-5-804-20

Dressing Forceps
20.5 cm, 22 cm, 26.5 cm, 20 cm, 21.5 cm,
26 cm



Tunneling Forceps

NI-5-805-40

Tunneling Forceps
39.5 cm



Collin

NI-5-806-25

Dressing Forceps
25.5 cm



Cheron

NI-5-807-25

Dressing Forceps
23.5 cm



Bozemann

NI-5-808-26

Sponge Forceps
26 cm

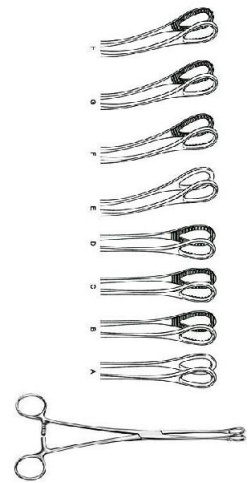

Foerster

NI-5-809-25

Sponge Forceps
25 cm , 18 cm, 20.5 cm, 24.5 cm, 17.5 cm,
20 cm, 24.5 cm

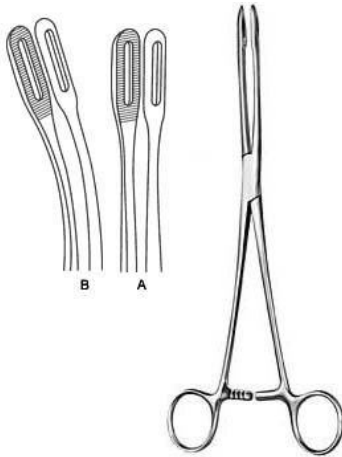

Foerster

NI-5-810-25

Sponge Forceps
25 cm , 24.5 cm

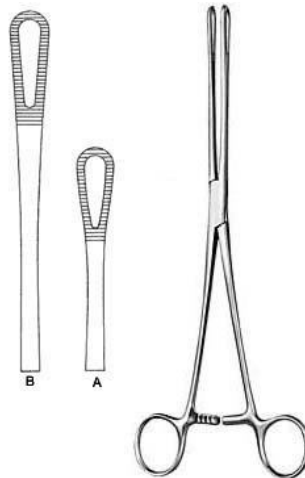

Rampley

NI-5-811-18

Sponge Forceps
18.5 cm , 24.5 cm



Vickers
NI-5-901-18
Skin Hooklet
18.5 cm



Vickers
NI-5-902-01
Bone Hooklet
17 cm



Vickers
NI-5-903-01
Tendon Hooklet
17 cm



Vickers
NI-5-904-02
Hooklet
16 cm

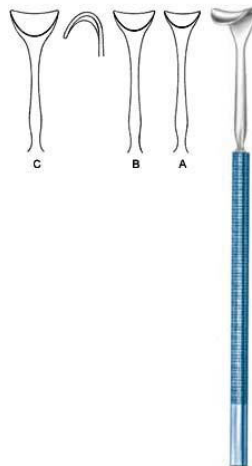

Vickers
NI-5-905-12
Saddle Hook
14 cm



Graefe
NI-5-906-01
Micro Hooklet
15 cm

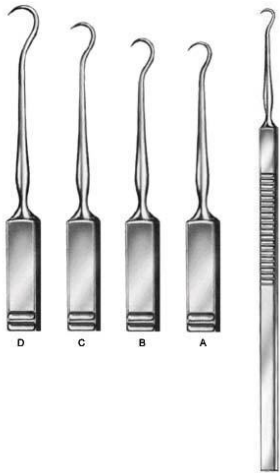

Skin Hook

NI-5-907-01

Skin Hook

16 cm Fig. 1, 16 cm Fig. 2, 16 cm Fig. 3, 16 cm Fig. 4



O Connor

NI-5-908-16

Skin Hook

16 cm

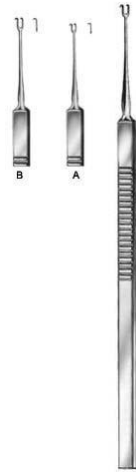

Guthrie

NI-5-909-01

Skin Hook

15.5 cm

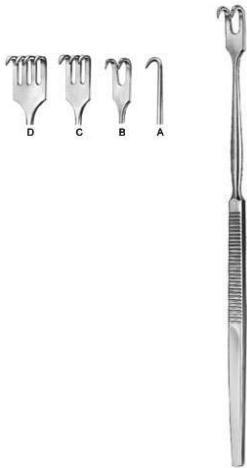

Hooklet

NI-5-910-01

Hooklet

16.5 cm



Hooklet

NI-5-911-01

Hooklet

16.5 cm



Hooklet

NI-5-912-02

Hooklet

16 cm



Hooklet

NI-5-913-04

Hooklet
16.5 cm



Vessel Hook

NI-5-914-12

Vessel Hook
12 cm

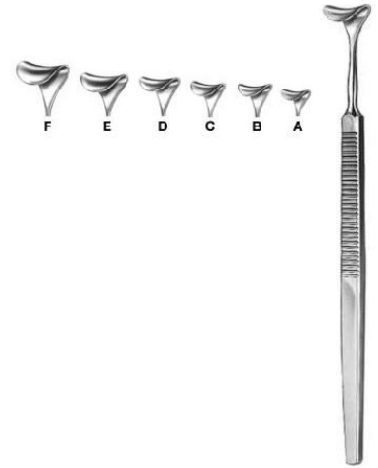

Desmarres

NI-5-915-08

Saddle Hook
16 cm 8 mm, 16 cm 10 mm, 16 cm 12 mm, 16 cm 14 mm, 16 cm 16 mm, 16 cm 18 mm

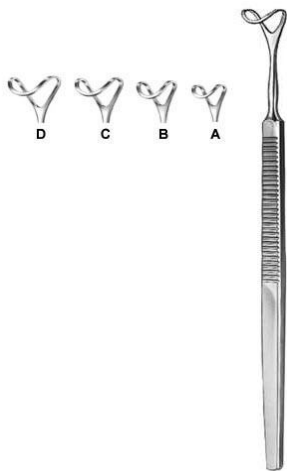

Saddle Hook

NI-5-916-12

Saddle Hook
16 cm 12 mm, 16 cm 14 mm, 16 cm 16 mm, 16 cm 18 mm

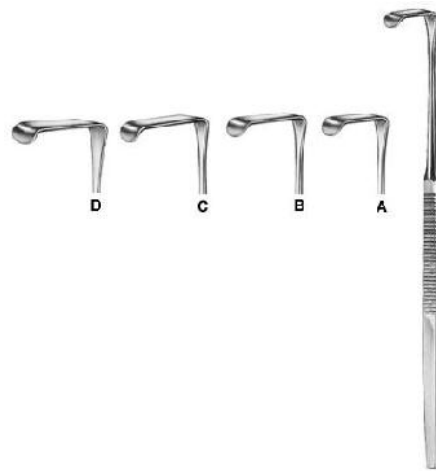

Langenbeck-Mini

NI-5-917-10

Langenbeck-Mini
16 cm



Hooklet

NI-5-918-16

Hooklet
16 cm 14 x 8



Hooklet

NI-5-919-01

Hooklet
16.5 cm



Hooklet

NI-5-920-01

Hooklet
16.5 cm



Meyerding

NI-5-921-01

Hooklet
17.5 cm Fig. 1, 17.5 cm Fig. 2, 17.5 cm Fig. 3, 17.5 cm Fig. 4, 17.5 cm Fig. 5, 17.5 cm Fig. 6



Senn-Green

NI-5-922-01

Hooklet
15 cm Fig. 1, 15 cm Fig. 2



Ragnell-Davis

NI-5-923-14

Hooklet
14 cm

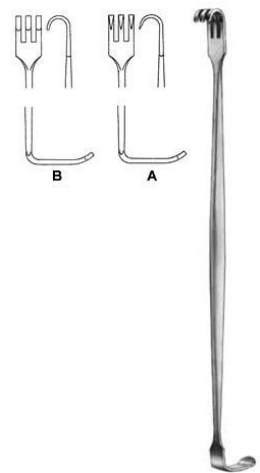

Senn-Miller

NI-5-924-16

Hooklet
16 cm



Cushing

NI-5-925-20

Cushing
20.5 cm



Cushing

NI-5-926-08

Saddle Hook
20.5 cm 8 mm wide, 20.5 cm 10 mm wide, 20.5 cm 12 mm wide, 20.5 cm 14 mm wide, 20.5 cm 16 mm wide, 20.5 cm 18 mm wide



Cushing

NI-5-927-08

Saddle Hook 8 mm to 18 mm wide
24 cm



Brom

NI-5-928-01

Vein Hook
19.5 cm



Strandell-Stillie

NI-5-929-01

Strandell-Stillie
19 cm Fig. 1, 19 cm Fig. 2

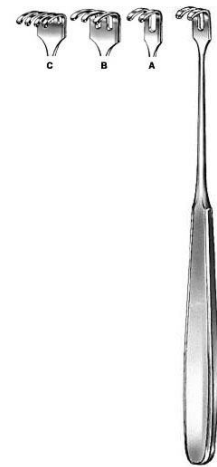

Klapp

NI-5-930-01

Retractor 12 x 6, 12 x 11, 15 x 11
17.5 cm



Hooklet

NI-5-931-04

Hooklet
16.5 cm

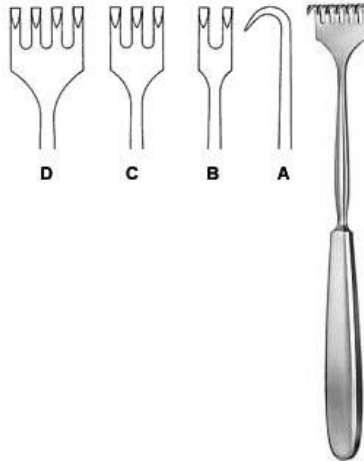

Volkmann

NI-5-932-01

Retractor
21.5 cm

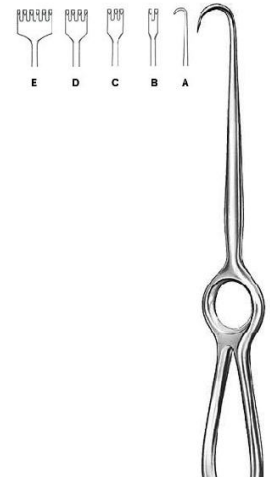

Volkmann

NI-5-933-01

Retractor
22 cm, 21.5 cm

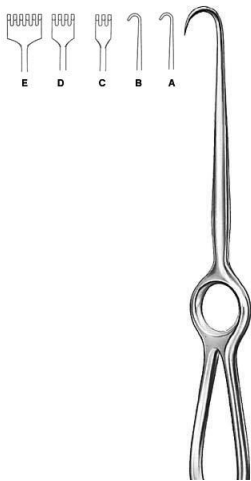

Kocher

NI-5-934-01

Retractor
22 cm

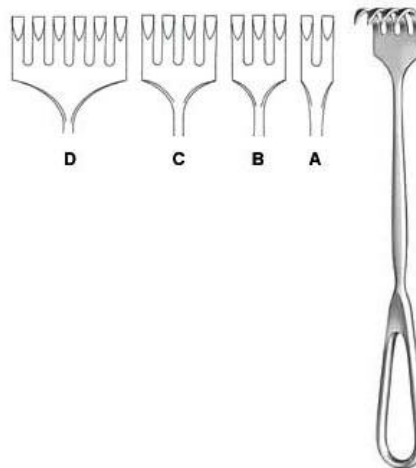

Martin

NI-5-935-02

Retractor
22.5 cm

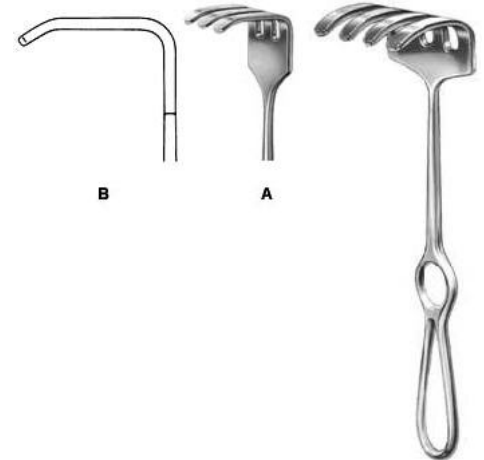

Ollier

NI-5-936-03

Retractor
23 cm 36 x 30, 23 cm 36 x 60



Wassmund

NI-5-937-02

Retractor
20.5 cm 33 x 21

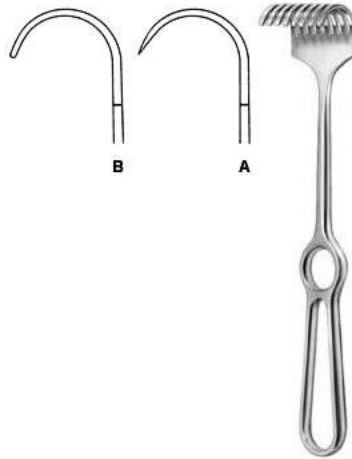

Korte

NI-5-938-08

Retractor
24.5 cm 40 x 30

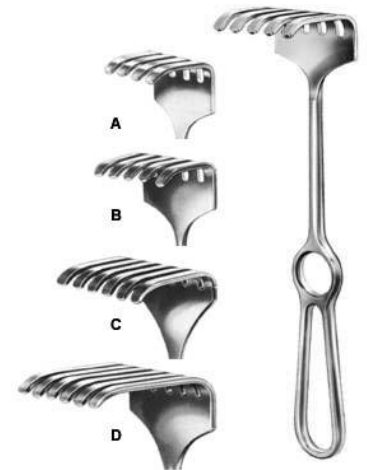

Israel

NI-5-939-04

Retractor
25.5 cm

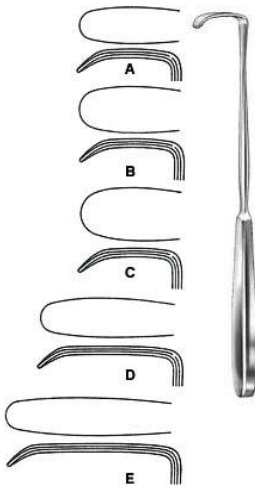

Langenbeck

NI-5-940-01

Retractor

22.5 cm 30 x 11 mm, 22.5 cm 30 x 14 mm,
22.5 cm 30 x 16 mm, 22.5 cm 40 x 11 mm,
22.5 cm 50 x 11 mm

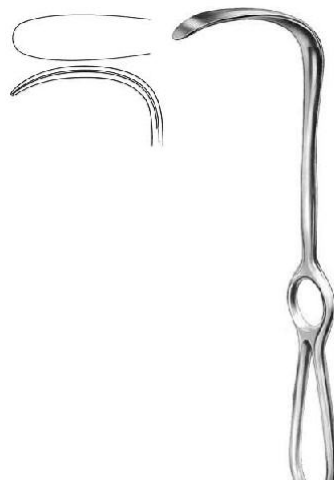

Langenbeck

NI-5-942-21

Retractor

21 cm 65 x 20 mm



Langenbeck

NI-5-943-21

Retractor

22.5 cm 85 x 15 mm

Retractors



Lahey

NI-5-944-19

Retractor

19.5 cm 36 x 19 mm



Little

NI-5-945-20

Retractor

20 cm 13 x 15 mm

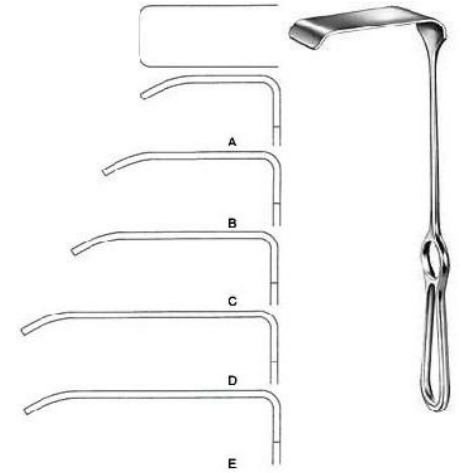

Kocher

NI-5-946-18

Retractor

23 cm 43 x 18 mm, 23 cm 53 x 20 mm, 23 cm 63 x 25 mm, 23 cm 77 x 30 mm, 23 cm 78 x 40 mm

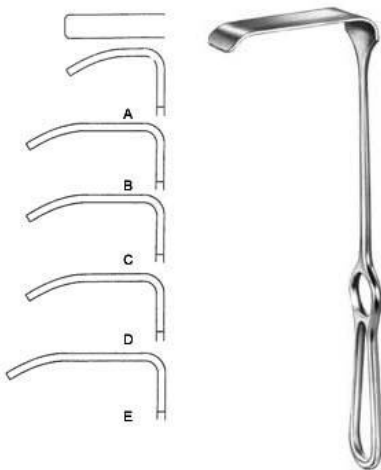

Kocher-Langenbeck

NI-5-947-01

Retractor

21.5 cm 25 x 6 mm, 21.5 cm 35 x 8 mm, 21.5 cm 35 x 11 mm, 21.5 cm 35 x 15 mm, 21.5 cm 40 x 11 mm, 21.5 cm 55 x 11 mm, 21.5 cm 70 x 14 mm, 21.5 cm 80 x 12 mm

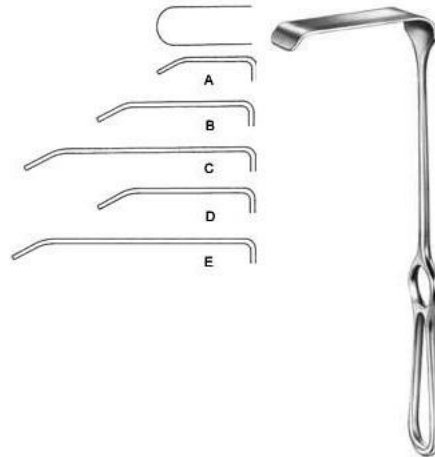

Kocher-Langenbeck

NI-5-948-01

Retractor

21.5 cm 25 x 10 mm, 21.5 cm 40 x 13 mm, 21.5 cm 60 x 13 mm, 21.5 cm 40 x 18 mm, 21.5 cm 60 x 18 mm, 21.5 cm 85 x 18 mm, 21.5 cm 60 x 25 mm, 21.5 cm 85 x 25 mm

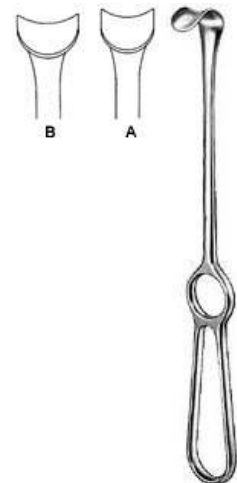

Kocher

NI-5-949-01

Retractor

21.5 cm 22 x 12, 21.5 cm 24 x 14 mm

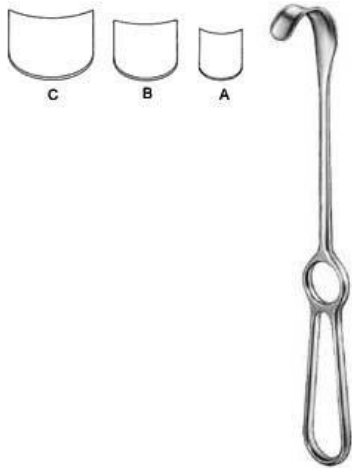

Kocher

NI-5-950-01

Retractor

22 cm 42 x 10 mm, 22 cm 42 x 15 mm, 22 cm 43 x 20 mm

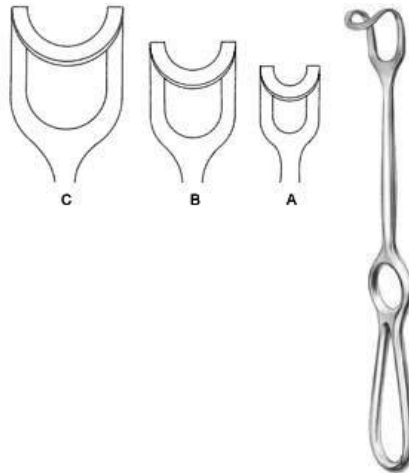

Middeldorpf

NI-5-951-01

Retractor

21.5 cm 18 x 17 mm, 23 cm 25 x 22 mm, 24.5 cm 30 x 31 mm



Doyen-Stillé

NI-5-952-01

Retractor

26 cm 97 x 29 mm, 26 cm 101 x 31 mm, 26 cm 127 x 52 mm



Hosel

NI-5-953-01

Retractor

26 cm 63 x 21 mm, 26 cm 83 x 30 mm, 26 cm 103 x 30 mm, 26 cm 120 x 30 mm, 26 cm 140 x 30 mm, 26 cm 140 x 40 mm

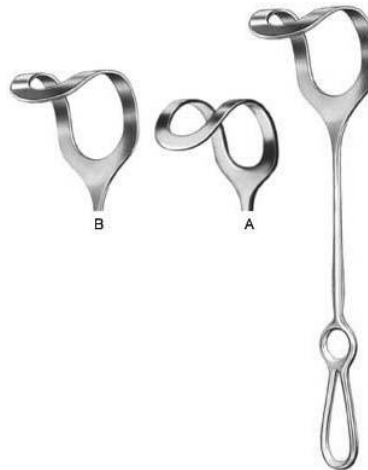

Middeldorpf

NI-5-954-01

Retractor

27 cm 48 x 45 mm, 27 cm 52 x 50 mm, 27 cm 60 x 70 mm

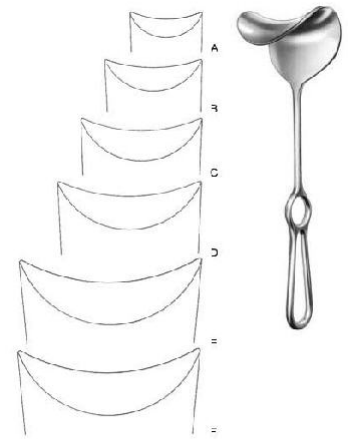

Fritsch

NI-5-955-00

Retractor

23.5 cm 37 x 31 mm, 24 cm 38 x 40 mm, 25 cm 43 x 51 mm, 25 cm 49 x 61 mm, 25.5 cm 48 x 75 mm, 25.5 cm 65 x 85 mm



Doyen

NI-5-956-25

Retractor

24 cm 48 x 88 mm



Kocher

NI-5-957-22

Retractor

24 cm 73 x 25 mm



Kocher

NI-5-958-01

Retractor

25 cm 80 x 45 mm, 25 cm 80 x 55 mm, 25 cm 80 x 65 mm



Martin

NI-5-959-25

Retractor

26 cm 110 x 27 mm

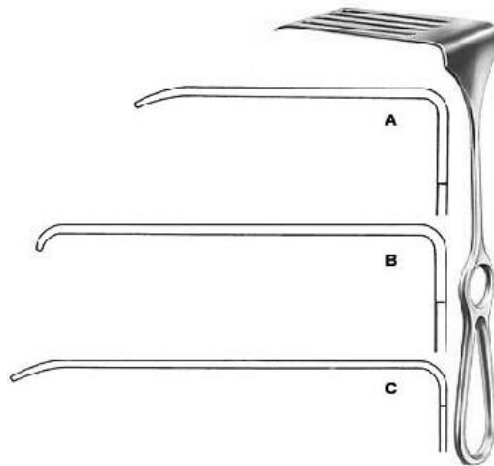

Coryllos

NI-5-960-01

Retractor

24 cm 85 x 22 mm, 24 cm 108 x 43 mm, 24 cm 119 x 65 mm



Davidson

NI-5-961-01

Retractor

19 cm 80 x 54 mm, 18.5 cm 80 x 95 mm

Retractors

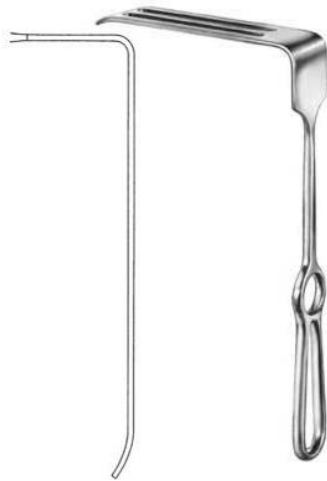

Sauerbruch

NI-5-962-25

Retractor

25.5 cm 127 x 38 mm

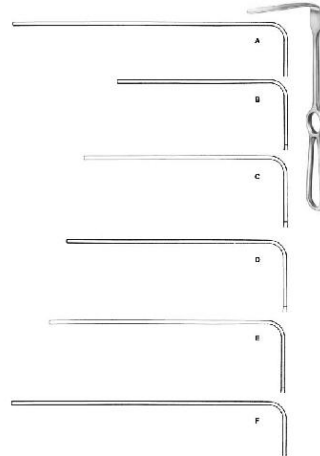

Brunner

NI-5-963-08

Retractor

25.5 cm 84 x 20 mm, 25.5 cm 104 x 25 mm, 25.5 cm 124 x 30 mm, 25.5 cm 130 x 30 mm, 25.5 cm 144 x 30 mm, 25.5 cm 160 x 30 mm, 25.5 cm 164 x 30 mm

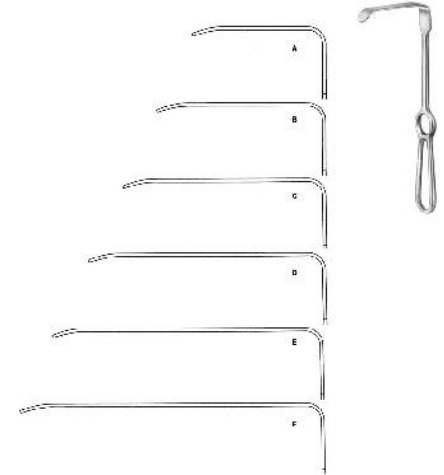

Brunner

NI-5-964-08

Retractor

25.5 cm 82 x 20 mm, 25.5 cm 102 x 20 mm, 25.5 cm 122 x 25 mm, 25.5 cm 140 x 25 mm, 25.5 cm 162 x 30 mm, 25.5 cm 182 x 30 mm

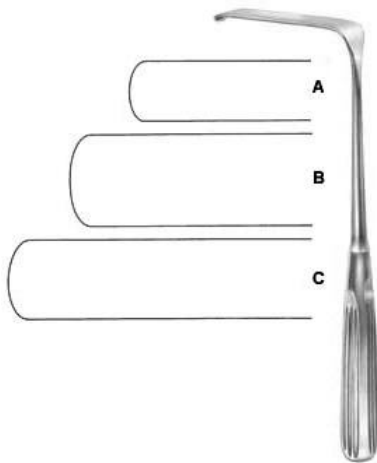

Sauerbruch

NI-5-965-01

Retractor

22.5 cm 50 x 15 mm, 22.5 cm 63 x 23 mm, 22.5 cm 80 x 20 mm



Deaver

NI-5-966-01

Retractor

18 cm 19 mm

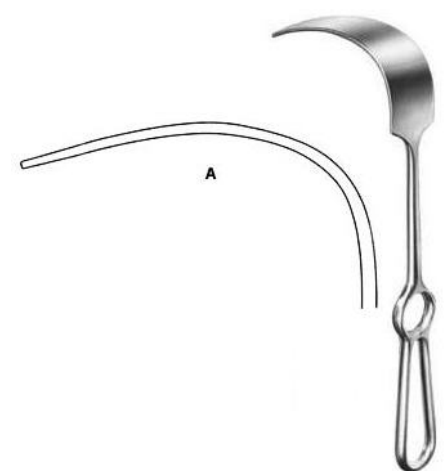

Mikulicz

NI-5-968-01

Retractor

25 cm 90 x 35 mm, 25 cm 125 x 50 mm, 25 cm 160 x 50 mm



Mikulicz

NI-5-969-26

Retractor

26 cm 90 x 55 mm

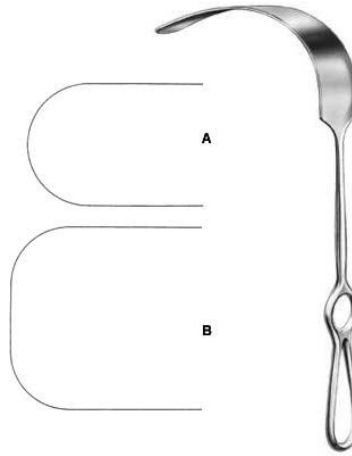

Kelly

NI-5-970-01

Retractor

27.5 cm 205 x 38 mm, 27.5 cm 205 x 57 mm



Farabeuf

NI-5-971-00

Retractor

15 cm Fig. 1 = 23 x 16, 15 cm Fig. 1 = 26 x 16, 15 cm Fig. 2 = 27 x 16, 15 cm Fig. 2 = 30 x 16

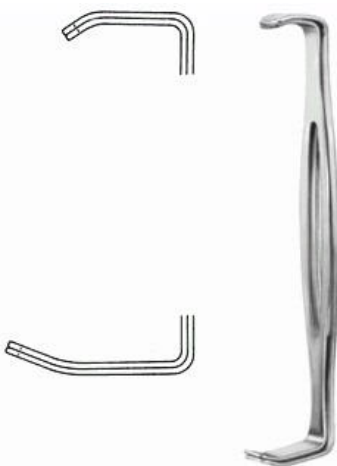

Parker-Langenbeck

NI-5-972-00

Retractor

21.5 cm Fig. 1 = 21x15 mm, 21.5 cm Fig. 1 = 40x15 mm, 21.5 cm Fig. 2 = 25x15 mm, 21.5 cm Fig. 2 = 45x15 mm



Alm

NI-5-973-07

Wound Spreaders, self-retaining

7 cm



Alm

NI-5-974-07

Wound Spreaders, self-retaining

7 cm



Gosset

NI-5-975-22

Abdominal Retractor
18.5 cm



Balfour-Baby

NI-5-976-00

Abdominal Retractor spreading 90mm, 1
central blade 24 x 20 mm
12.5 cm



Balfour

NI-5-977-00

Abdominal retractor spreading 180 mm,
lateral blades 70 x 35 mm, 1 central blade
20 cm

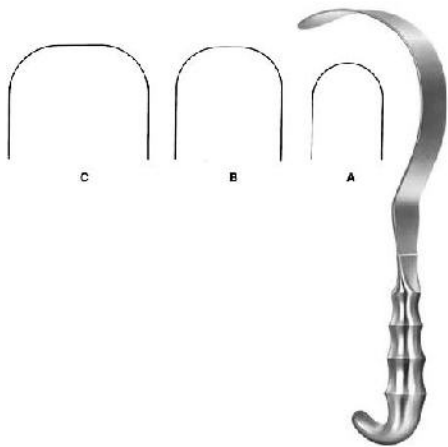

Deaver

NI-5-967-04

Retractor

31.5 cm 25 mm, 31.5 cm 38 mm, 31.5 cm
50 mm, 31.5 cm 100 mm



Probe

NI-5-1001-11

Probe

11.5cm, 13 cm , 14.5 cm , 16 cm, 18 cm, 20cm, 25 cm , 30 cm



Probe

NI-5-1002-11

Probe

11.5 cm, 13 cm , 14.5 cm , 16 cm, 18 cm, 20cm, 25 cm , 30 cm



Probe

NI-5-1003-13

Probe

13 cm , 14.5 cm , 16 cm, 18 cm, 20 cm, 25 cm



Probe With Eye

NI-5-1004-13

Probe with eye

13 cm , 14.5 cm , 16 cm

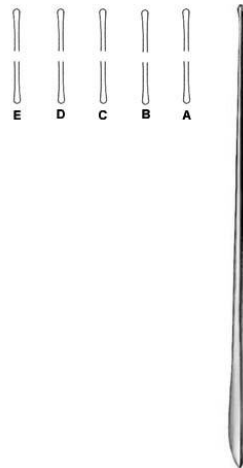

Myrtle Leaf Probe

NI-5-1006-13

Myrtle Leaf Probe

13 cm , 14.5 cm , 16 cm, 18 cm, 20 cm



Grooved Director

NI-5-1007-13

Grooved Director

13 cm , 14 cm, 16 cm



Grooved Director

NI-5-1008-13

Grooved Director
13 cm , 14.5 cm , 16 cm



Doyen

NI-5-1009-14

Grooved Director
14.5 cm



Nelaton

NI-5-1010-16

Grooved Director
16 cm

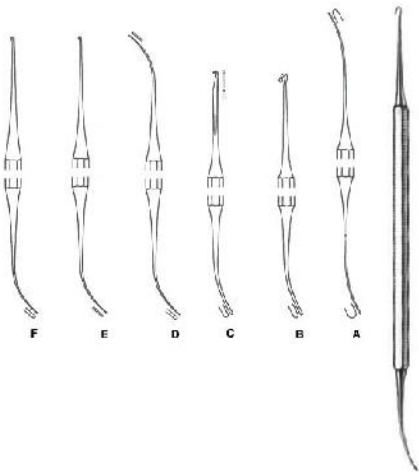

Varady

NI-5-1011-01

Phlebdissector
18 cm, 17.5 cm

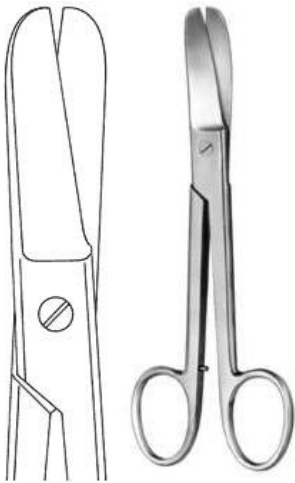

Lorenz

NI-6-101-23

Bandage Scissors heavy pattern
23 cm



Lister

NI-6-102-14

Bandage Scissors
14.5 cm , 18.5 cm , 20 cm

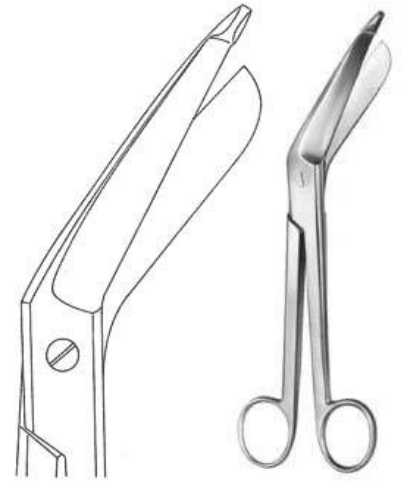

Bergmann

NI-6-103-23

Plaster Shears
23.5 cm



Esmarch

NI-6-104-20

Plaster Shears heavy pattern, short
blades
20 cm



**Bandage Scissors Black Plastic
Ring With Autodavable**

NI-6-105-15

Bandage Scissors black plastic ring with
autodavable
16 cm, 19 cm



**Bandage Scissors Black Plastic
Rings**

NI-6-106-18

Bandage Scissors black plastic rings
16 cm, 19 cm

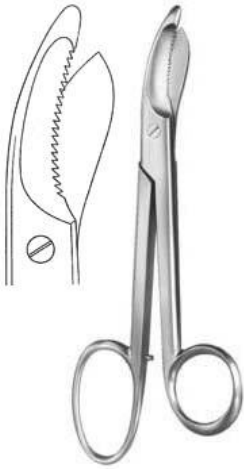

Bruns

NI-6-107-24

Plaster Scissors
24 cm

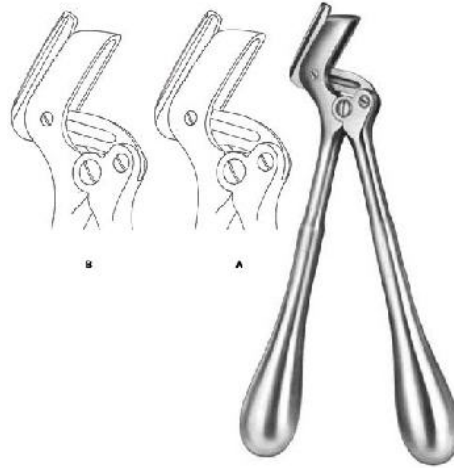

Stille-Martin

NI-6-108-23

Plaster Shears
23 cm , 27 cm, 38 cm

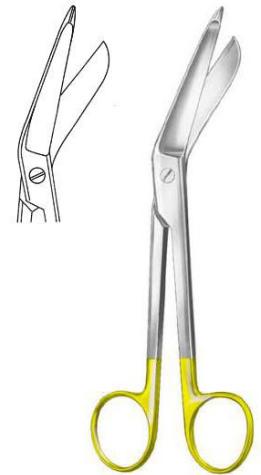

Lister

NI-6-109-18

Bandage Scissors
18 cm



Bruns

NI-6-110-24

Plaster Scissors
24 cm



Hopkins

NI-6-111-20

Plaster Knife with wooden handle
20 cm



Reiner

NI-6-112-18

Plaster Knife
18 cm



Reiner

NI-6-113-18

Plaster Knife
18 cm



Martin

NI-6-114-21

Plaster Knife with wooden handle
21 cm



Engel

NI-6-115-14

Plaster Saw
15.5 cm



Hennig

NI-6-116-28

Plaster Spreader
28 cm

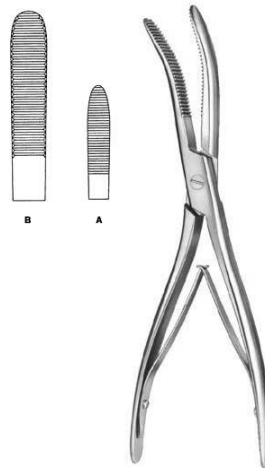

Wolff

NI-6-117-18

Plaster Breaker
18 cm, 26.5 cm



Gigli

NI-8-101-01

Wire Saw Handle



De Martel

NI-8-102-33

Wire Saw Guide
33 cm



Crutchfield

NI-8-103-01

Skull Traction Tong small pattern



**Skull Traction Tong Large
Pattern**

NI-8-104-01

Skull Traction Tong large pattern
22.5 cm



Dahlgren

NI-8-105-20

Cranial Rongeur
20 cm



Olivecrona-Toennis

NI-8-106-14

Clip Applying Forceps



McKenzie

NI-8-107-19

Clip Applying Forceps
18.5 cm



Olivecrona

NI-8-108-18

Dura Dissector
18 cm



Olivecrona

NI-8-109-19

Dura Dissector
20 cm



Milligan

NI-8-110-21

Dura Dissector
21.5 cm



Davis

NI-8-111-21

Dura Dissector sharp
21.5 cm



Dura Dissector

NI-8-112-22

Dura Dissector
22 cm



Davis

NI-8-113

Dura Dissector
24.5 cm



Love

NI-8-114-19

Nerve Root Retractor
21.5 cm, 18 cm, 11 cm



Olivecrona

NI-8-115-18

Brain Spatula
18 cm



Scoville

NI-8-116-23

Nerve Root Retractor 8mm
23.5 cm



Holsher

NI-8-117-24

Nerve Root Retractor 8mm
23.5 cm

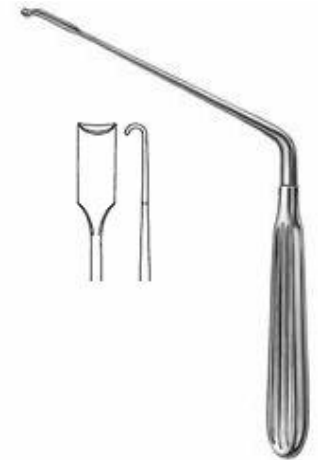

Scoville

NI-8-118-19

Nerve Root Retractor 7mm
16.5 cm



Groningen

NI-8-119-26

Nerve Hook
26.5 cm



Groningen

NI-8-120-26

Nerve Hook
26.5 cm



Cushing

NI-8-121-19

Nerve Hook blunt
19 cm , 28 cm

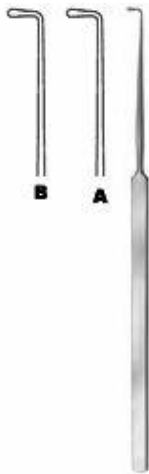

Cushing

NI-8-122-19

Nerve Hook
19.5 cm , 28 cm



Smithwick

NI-8-123-17

Smithwick
17 cm , 21 cm



Halle

NI-8-125-20

Dura Knife
20 cm



Adson
NI-8-126-20
Dura Hook
20 cm



Graham
NI-8-127-16
Dura Hook blunt
16.5 cm



Sachs
NI-8-128-18
Dura Hook sharp
18 cm



Toennis
NI-8-129-15
Dura Hook sharp
14.5 cm



Frazier
NI-8-130-13
Dura Hook sharp
13 cm , 18 cm



Krayenbuhl
NI-8-131-01
Nerve and Vessel Hooklet
18.5 cm Fig. 1 , 18.5 cm Fig. 2



Cloward

NI-8-132-16

Lamina Spreader
16 cm

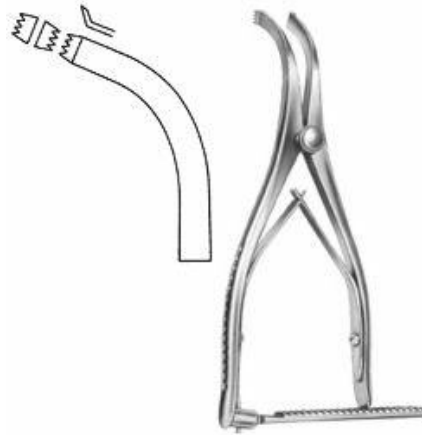

Inge

NI-8-133-17

Lamina Spreader
16 cm

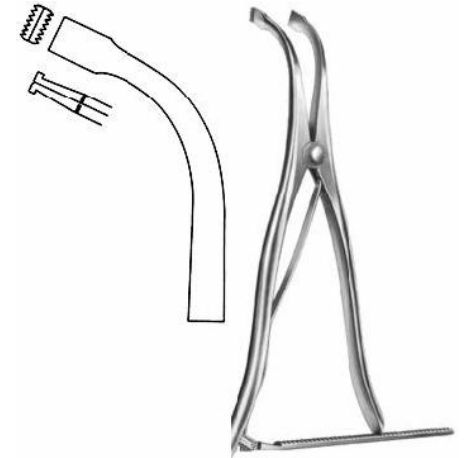

Inge

NI-8-134-27

Lamina Spreader
25.5 cm

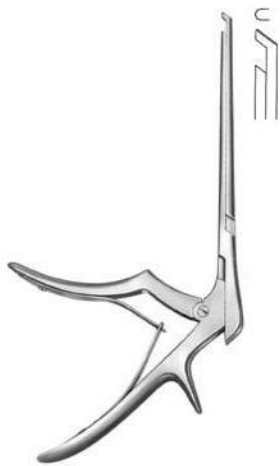

Ferris-Smith Kerrison

NI-8-135-03

Laminectomy Punch 3mm downwards
cutting 40 degree shaft length 180 mm

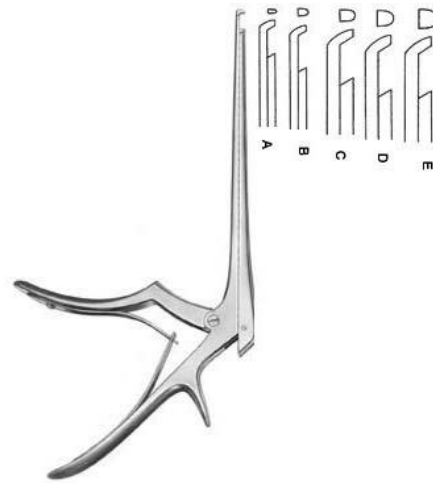

Ferris-Smith Kerrison

NI-8-138-01

Laminectomy Punch upwards cutting
shaft length 180 mm
1 mm, 2 mm, 3 mm, 4 mm, 5 mm, 6 mm

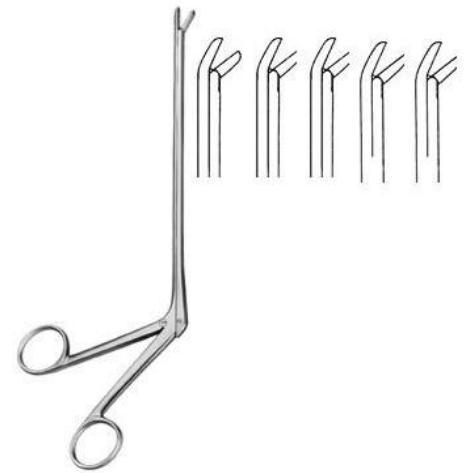

Cushing

NI-8-139-01

Laminectomy Rongeur jaw 2 x 10 to 4 x
10 mm straight shaft length 180 mm

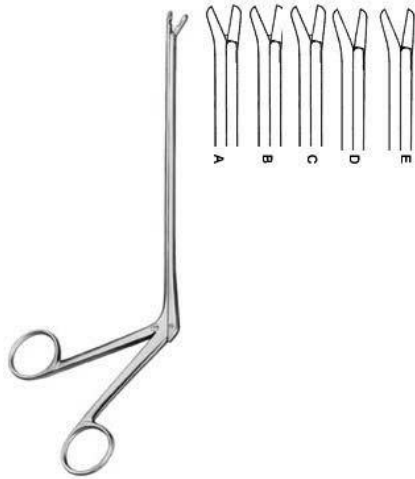

Cushing

NI-8-140-01

Laminectomy Rongeur jaw 2 x 10 to 4 x 10 mm upwards 45 degree shaft length 120 mm

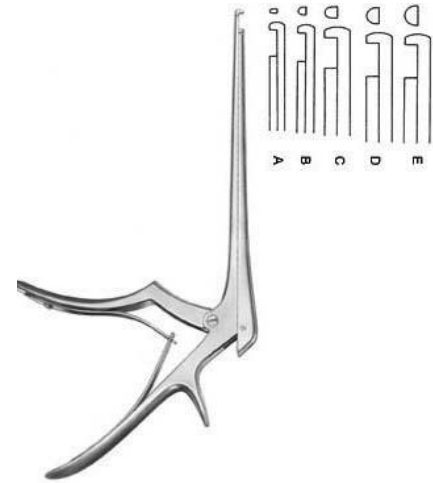

Ferris-Smith Kerrison

NI-8-137-01

Laminectomy Punch
1 mm, 2 mm, 3 mm, 4 mm, 5 mm, 6 mm



Bone Shear

NI-9-101-23

Bone Shear
23 cm



Rib Shear

NI-9-102-22

Rib Shear
23 cm



Gluck

NI-9-103-22

Rib Shears
21 cm



Giertz-Stille

NI-9-104-27

Rib Shear
24.5 cm



Lebsche

NI-9-105-24

Sternum Chisel
24.5 cm



Rib Retractor

NI-9-106-01

Rib Retractor lateral blades 12 x 16 mm
spreading 95 mm

Size 1



Finochietto, Infant

NI-9-107-01

Rib Retractor lateral blades 15 x 15 mm
spreading 75 mm
Size 1



Finochietto, Baby

NI-9-108-01

Rib Retractor lateral blades 31 x 31 mm
spreading 100 mm
Size 1



Finochietto

NI-9-109-01

Rib Retractor lateral blades 40 x 45 mm
spreading 135 mm
Size 1



Burford

NI-9-110-01

Rib Retractor with two pairs of blades 47
x 62 mm + 65 x 62 mm, spreading 200
mm
Size 1



Castaneda

NI-9-111-01

Rib Retractor lateral blades 10,5 x 32 mm
spreading 65 mm
Size 1



Finochietto (Modif.)

NI-9-112-01

Rib Retractor lateral blades 14 x 15 mm
spreading 120 mm
Size 1



Haight

NI-9-113-90

Rib Retractor lateral blades 30 x 30 mm
spreading 120 mm
Size 1



Morse-Favaloro

NI-9-114-01

Sternal Retractor 4 movable blades 17 x
22 mm spreading 160 mm Sternal
Retractor
Size 1



Morse

NI-9-115-00

Sternal Retractor 4 movable blades 22 x
27 mm spreading 200 mm
Size 1



Tuffier

NI-9-116-02

Rib Retractor lateral blades 22 x 27 mm
spreading 200 mm
Size 1

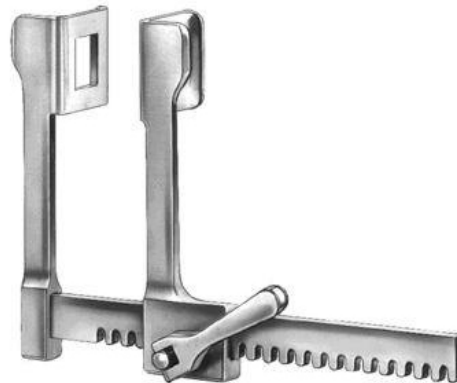

Finochietto, Baby

NI-9-117-75

Rib Retractor lateral blades 14 x 15 mm
spreading 75 mm
Size 1



Finochietto

NI-9-118-01

Rib Retractor lateral blades 30 x 45 mm
spreading 150 mm
Size 1



DeBakey

NI-9-119-00

Rib Retractor spreading 150 mm
Size 1



DeBakey

NI-9-120-00

Rib Retractor spreading 200 mm
Size 1



Thoracic Retractor

NI-9-121-00

Thoracic Retractor
Size 1



Sellors

NI-9-121-00

Rib Contractor
20 cm



Bailey-Baby

NI-9-123-14

Rib Contractor
15.5 cm



Bailey

NI-9-124-16

Rib Contractor
20 cm



Bailey-Gibbon

NI-9-125-16

Rib Contractor
20 cm



Allison

NI-9-126-30

Lung Spatula
29.5 cm, 32.5 cm



Price-Thomas

NI-9-127-22

Bronchus Clamp
22 cm

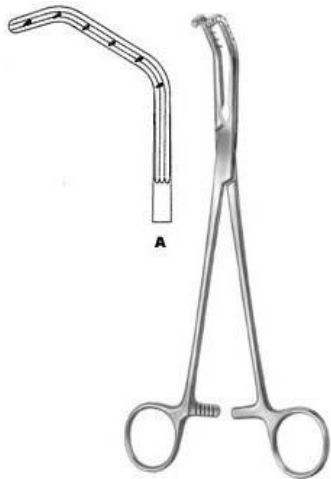

Price-Thomas

NI-9-128-22

Bronchus Clamp
22 cm

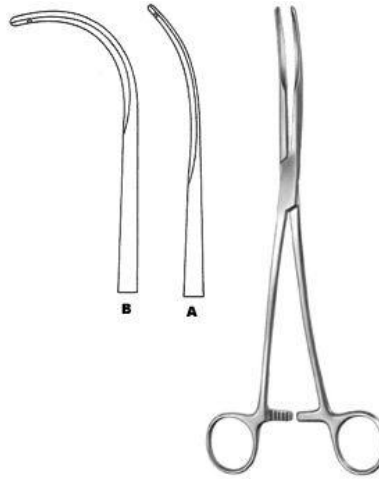

Semb

NI-9-129-24

Bronchus Clamp
24.5 cm



Lovelace

NI-9-130-20

Lung Grasping Forceps
20.5 cm

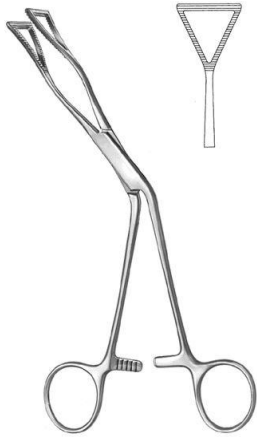

Lovelace

NI-9-131-20

Lung Grasping Forceps
19 cm



DeBakey-Satinsky

NI-9-132-07

Bulldog Clamp
7", 9 cm



Glover

NI-9-133-06

Bulldog Clamp
6 cm



Santulli

NI-9-134-07

Bulldog Clamp
7



Gregory, Soft

NI-9-135-09

Bulldog Clamp
9 cm, 11 cm



Gregory

NI-9-136-01

Bulldog Clamp
10.5 cm



DeBakey-Rankin

NI-9-137-16

Haemostatic Forceps
16 cm



DeBakey-Mosquito

NI-9-138-15

Haemostatic Forceps
15 cm



Ochsner

NI-9-139-23

Aortic Clamp
23.5 cm



Diethrich

NI-9-140-21

Aortic Clamp
22 cm

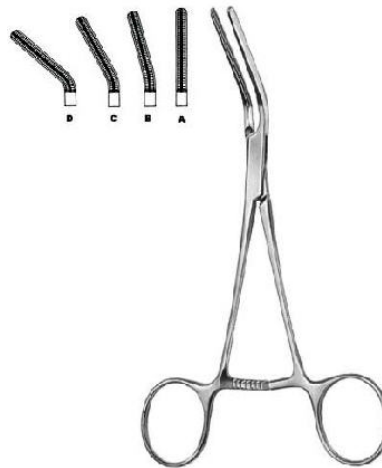

Dardik

NI-9-141-00

Multi purpose Vascular Clamp
15 cm



Dale

NI-9-142-18

Peripheral Vascular Clamp
18 cm

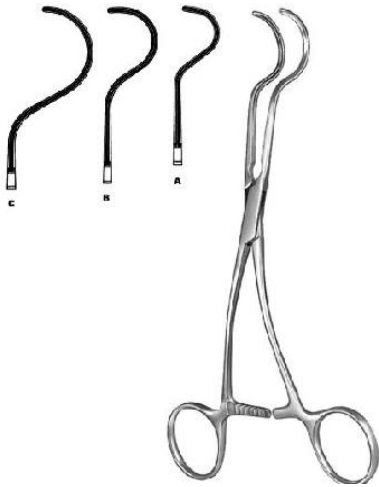

Dale

NI-9-143-17

Peripheral Vascular Clamp
17.5 cm

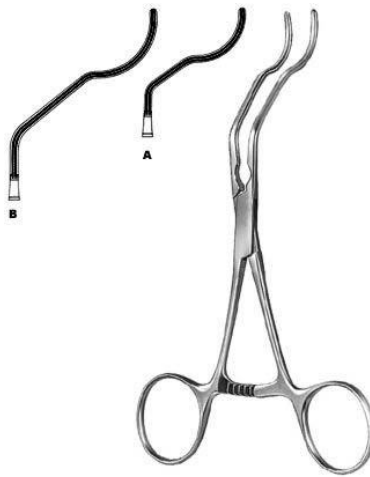

Gregory

NI-9-144-14

Profunda Clamp
13 cm , 16 cm, 18 cm

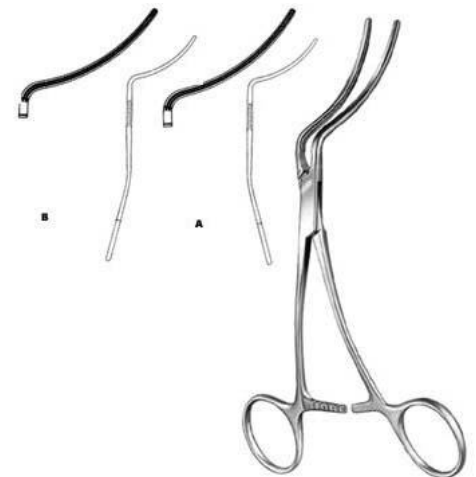

Martin

NI-9-145-16

Peripheral Vascular Clamp
16.5 cm



Husfeldt

NI-9-146-18

Peripheral Vascular Clamp
17.5 cm



Husfeldt

NI-9-147-18

Peripheral Vascular Clamp
18 cm

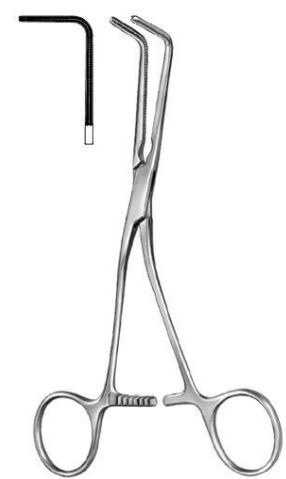

Husfeldt

NI-9-148-17

Peripheral Vascular Clamp
17 cm



DeBakey

NI-9-155-07

Bulldog Clamp

7



Applying Forceps

NI-9-156-23

Applying Forceps

23.5 cm

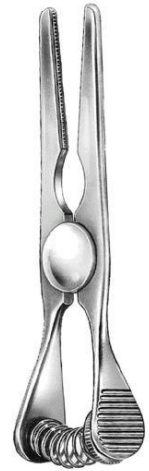

Glover

NI-9-157-06

Bulldog Clamp

7



Glover

NI-9-158-06

Bulldog Clamp

6.5 cm

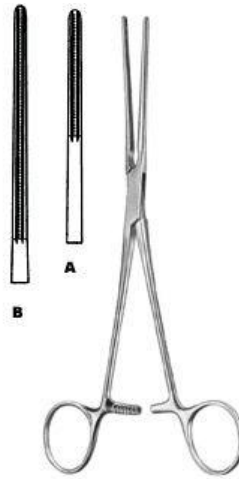

Potts

NI-9-159-21

Coarctation Clamp

21 cm

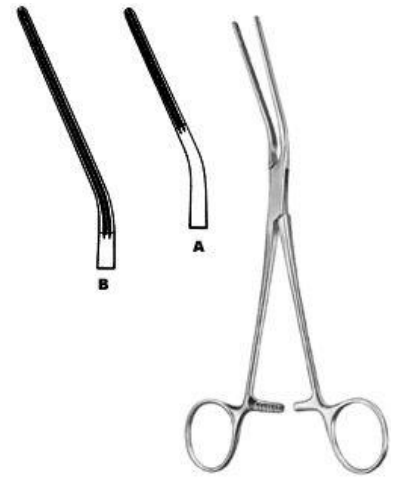

Potts

NI-9-160-21

Coarctation Clamp

20.5 cm

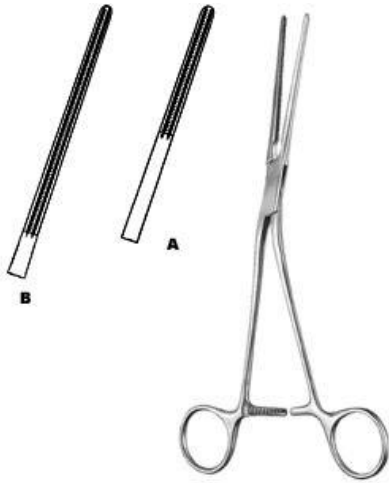

Potts

NI-9-161-21

Coarctation Clamp
20.5 cm



Potts

NI-9-162-22

Anastomosis Clamp
21.5 cm



Potts

NI-9-163-22

Anastomosis Clamp
22 cm

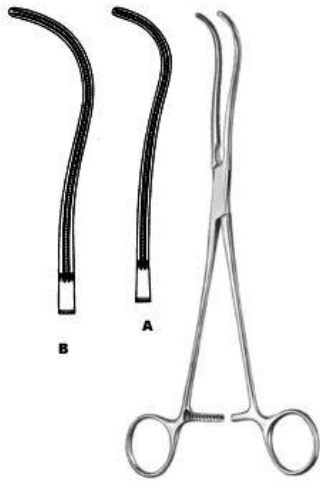

DeBakey

NI-9-164-19

Ligature Forceps
19 cm



DeBakey

NI-9-165-16

Peripheral Vascular Clamp
16 cm



DeBakey

NI-9-166-19

Peripheral Vascular Clamp
16 cm

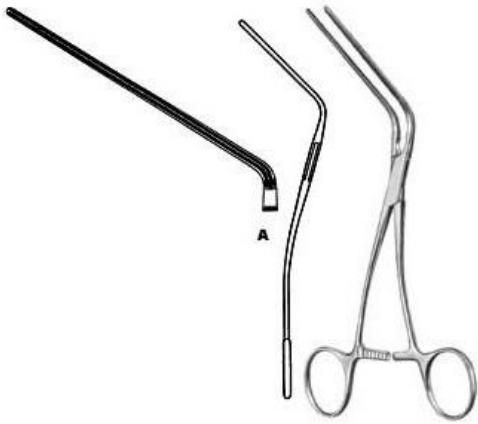

Leland-Jones

NI-9-167-18

Peripheral Vascular Clamp
18 cm

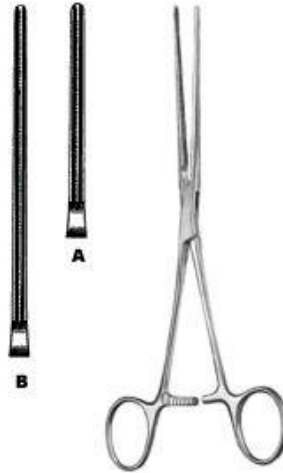

Bainbridge

NI-9-168-15

Multi purpose Vascular Clamp
15 cm



Bainbridge

NI-9-169-15

Multi purpose Vascular Clamp
15 cm

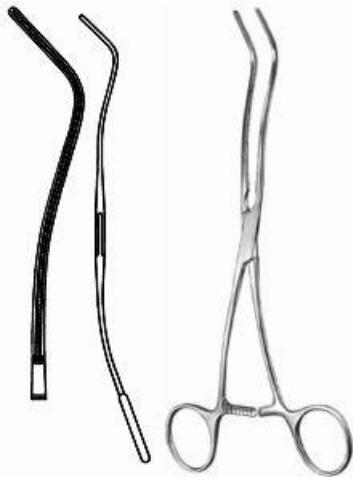

DeBakey

NI-9-170-20

Multi purpose Vascular Clamp
20 cm



DeBakey

NI-9-171-26

Aortic Aneurysm Clamp
26 cm



DeBakey

NI-9-172-28

Aortic Aneurysm Clamp
28 cm



DeBakey

NI-9-173-30

Aortic Aneurysm Clamp
30 cm



DeBakey

NI-9-174-27

Aortic Clamp
27 cm



DeBakey

NI-9-175-24

Ligature Forceps
24.5 cm



DeBakey

NI-9-176-24

Ligature Forceps
24.5 cm

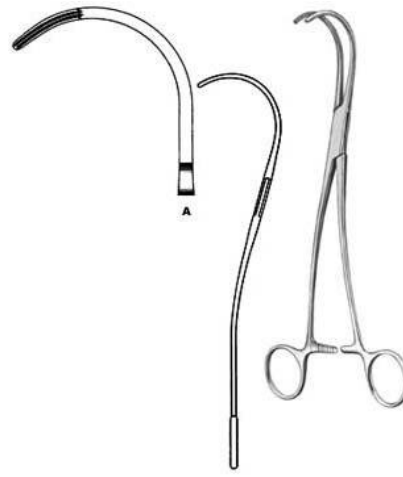

DeBakey

NI-9-178-25

Ligature Forceps
27 cm

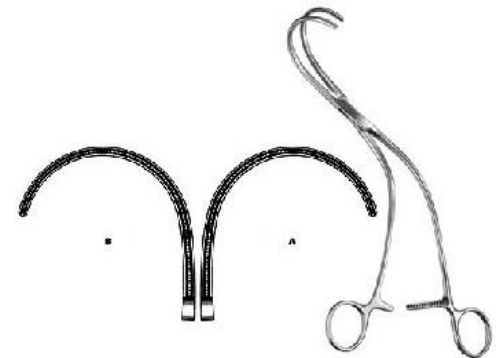

Weber

NI-9-179-01

Aortic Clamp
24 cm



Satinsky

NI-9-180-20

Tangential Occlusion Clamp
22 cm



Harken

NI-9-181-01

Auricle Clamp
24.5 cm



Lees

NI-9-182-23

Bronchus Clamp
23 cm



Lees

NI-9-183-25

Bronchus Clamp
25 cm



Lambert-Kay

NI-9-184-21

Anastomosis Clamp
22.5 cm



DeBakey

NI-9-185-17

Anastomosis Clamp
16.5 cm



Morris-DeBakey

NI-9-186-18

Aortic Clamp
16.5 cm



DeBakey-Bahnson

NI-9-187-23

Aneurysm Clamp
23.5 cm

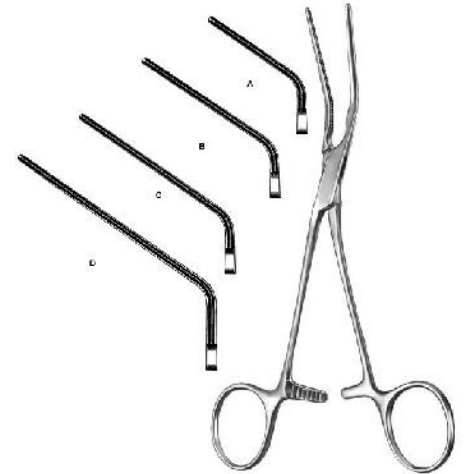

DeBakey

NI-9-188-20

Multi purpose Vascular Clamp
18 cm

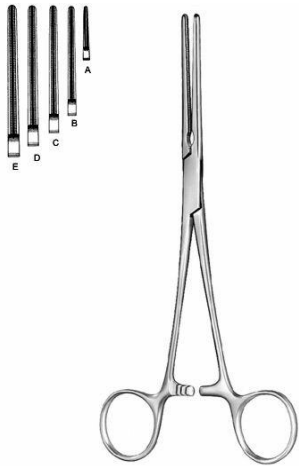

DeBakey-Mosquito

NI-9-189-12

Haemostatic Forceps
12.5 cm



DeBakey-Mosquito

NI-9-190-12

Haemostatic Forceps
12.5 cm



DeBakey

NI-9-191-17

Multi purpose Vascular Clamp
17 cm



DeBakey

NI-9-192-16

Multi purpose Vascular Clamp
16.5 cm

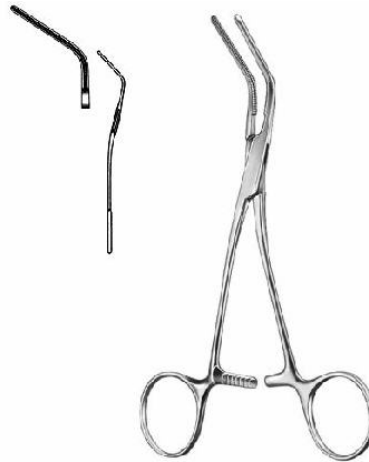

DeBakey

NI-9-193-15

Multi purpose Vascular Clamp
16 cm

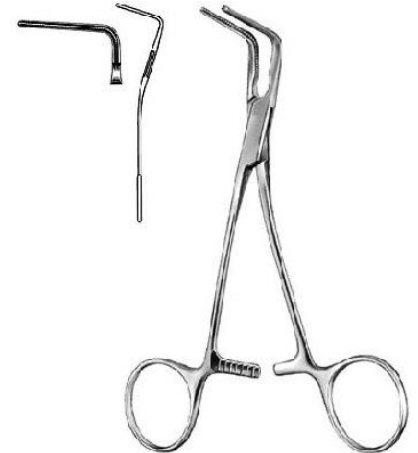

DeBakey

NI-9-194-15

Multi purpose Vascular Clamp
16.5 cm



DeBakey

NI-9-195-17

Multi purpose Vascular Clamp
16.5 cm



Glover

NI-9-196-17

Multi purpose Vascular Clamp
17 cm



Glover

NI-9-197-17

Multi purpose Vascular Clamp
17.5 cm

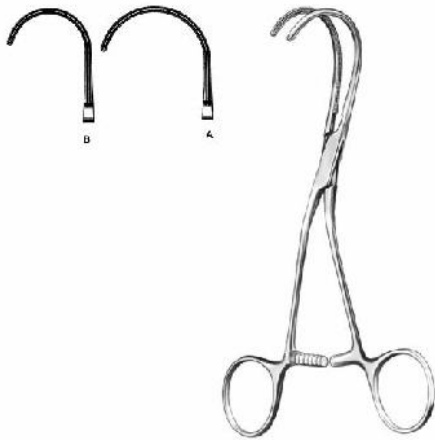

DeBakey

NI-9-198-16

Multi purpose Vascular Clamp
16.5 cm

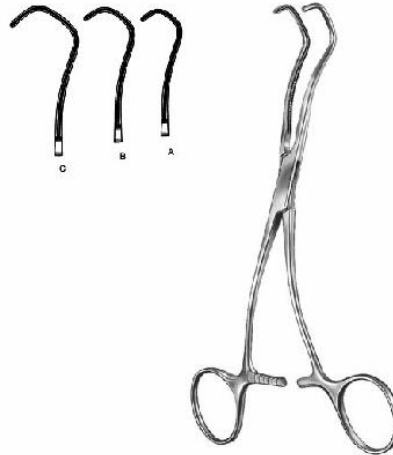

Derra

NI-9-199-16

Anastomosis Clamp
16 cm Fig. 1, 17.5 cm Fig. 3, 18.5 cm Fig. 3



DeBakey-Beck

NI-9-200-17

Anastomosis Clamp
17 cm



Cooley

NI-9-201-16

Vascular Forceps
16 cm

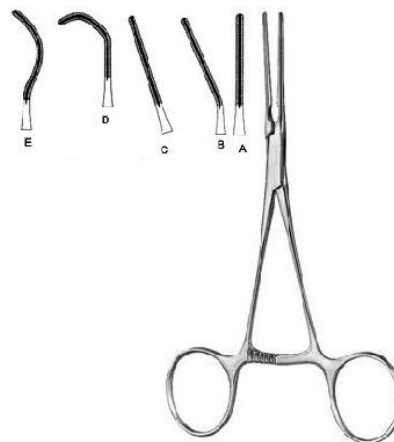

Cooley

NI-9-202-01

Pediatric Vascular Clamp
14.5 cm

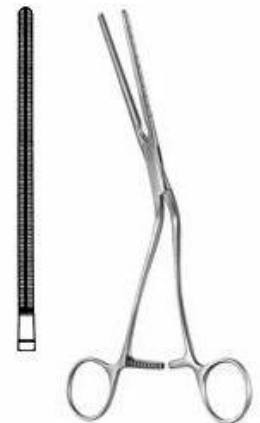

Cooley

NI-9-203-21

Iliac Clamp
22 cm



Cooley

NI-9-204-17

Anastomosis Clamp
17 cm

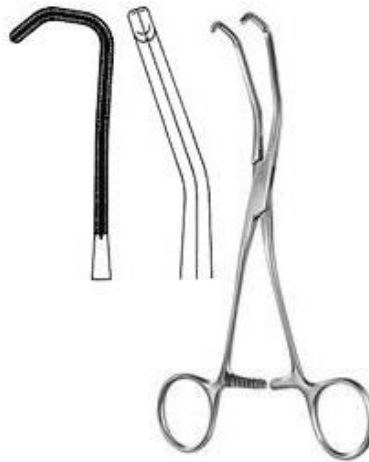

Cooley

NI-9-205-17

Anastomosis Clamp
20 cm



Cooley

NI-9-206-16

Anastomosis Clamp
17 cm



Cooley

NI-9-207-15

Multi purpose Vascular Clamp
16 cm



Cooley

NI-9-208-17

Multi purpose Vascular Clamp
17 cm



Cooley

NI-9-209-17

Multi purpose Vascular Clamp
17 cm



Cooley

NI-9-210-17

Multi purpose Vascular Clamp
17.5 cm

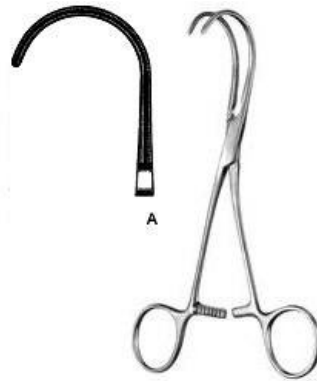

Cooley

NI-9-211-16

Multi purpose Vascular Clamp
16.5 cm



Cooley-Derra

NI-9-212-16

Anastomosis Clamp
16.5 cm



Cooley-Beck

NI-9-213-17

Anastomosis Clamp
17 cm

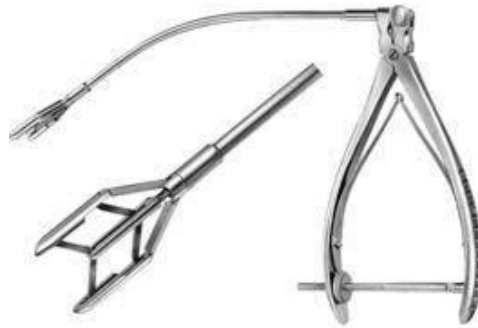

Cooley

NI-9-214-00

Aortic Dilator



Cooley

NI-9-215-05

Vascular Dilator
14 cm / 5 ? 11



DeBakey

NI-9-216-05

Vascular Dilator
19 cm

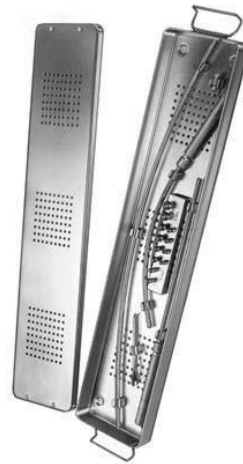

Martin

NI-9-217-00

Tunneling Set complete set with three shafts, two handles and 12 tips in storage case.



Hach

NI-9-218-01

Fasciotomy Knife with plastic handle
30 cm



Intima Spatula

NI-9-219-18

Intima Spatula
18.5 cm

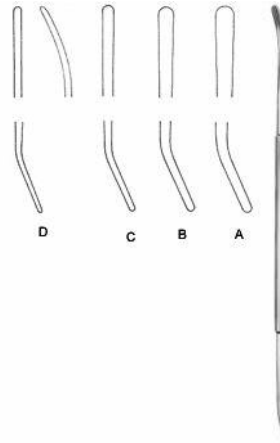

Robb

NI-9-220-01

Vascular Dissector
24 cm Fig. 1 2,5 mm ? , 24 cm Fig. 2 2,0 mm ?



Crile

NI-9-221-20

Nerve Hooklet
20 cm

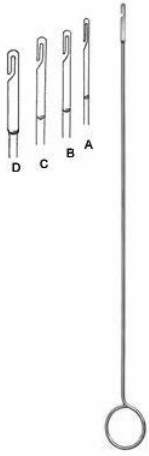

Ligature Catcher

NI-9-222-15

Ligature Catcher
26 cm 1,5 mm



Subramanian-Miniature

NI-9-223-15

Aortic Clamp 135 degree
15.5 cm

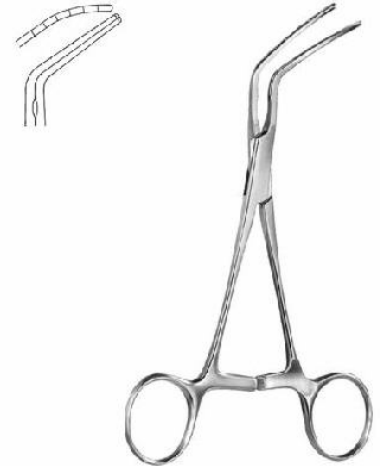

Subramanian

NI-9-224-16

Aortic Clamp
16 cm

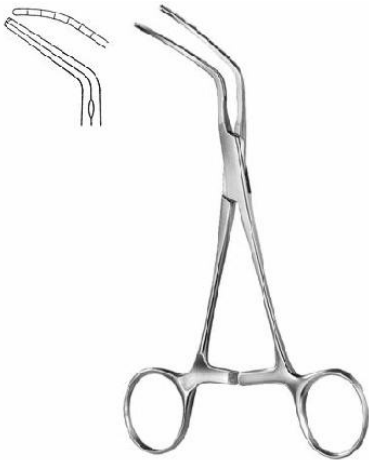

Subramanian

NI-9-225-16

Aortic Clamp

14 cm Fig. 1 , 14 cm Fig. 2 , 14 cm Fig. 3

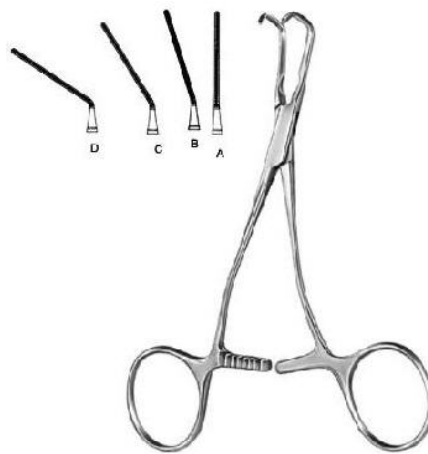

Pediatric Vascular Clamp

NI-9-226-01

Pediatric Vascular Clamp



Pediatric Vascular Clamp

NI-9-227-16

Pediatric Vascular Clamp

16.5 cm



Pediatric Vascular Clamp

NI-9-228-16

Pediatric Vascular Clamp

16 cm

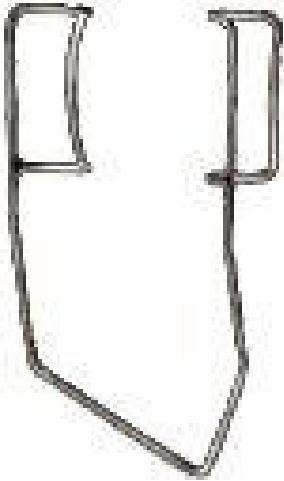

Barraquer (Colibri)

NI-11-101-03

Barraquer
Size 1

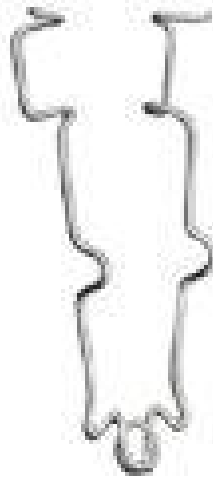

Bowman

NI-11-102-07

Bowman
Size 1



Critchett

NI-11-103-06

Critchett
Size 1

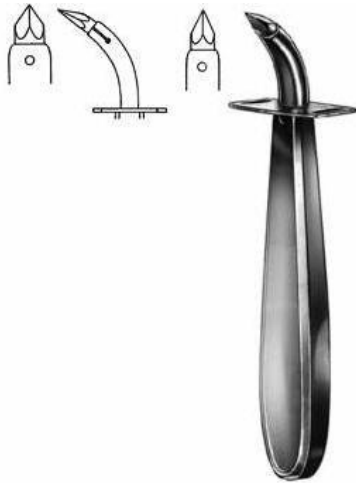

Ueckermann

NI-16-101-13

Tracheotomy Trocar
11.5 cm



Iterson

NI-16-102-16

Tracheal Hook
17 cm



Rose

NI-16-103-13

Tracheal Hook
13.5 cm



Luer

NI-16-104-11

Tracheal Hook
11 cm

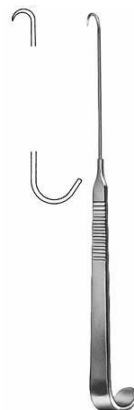

Tracheal Hook

NI-16-105-15

Tracheal Hook
15 cm



Lukens

NI-16-106-17

Thymus Retractor
17.5 cm



Jackson

NI-16-107-17

Tracheal Hook
18 cm



Kocher

NI-16-108-15

Goitre Enucleator
16.5 cm



Kocher

NI-16-109-15

Goitre Enucleator
16.5 cm



Hofmeister

NI-16-110-21

Goitre Enucleator
20.5 cm



Lahey

NI-16-111-15

Goitre Grasping Forceps
15.5 cm



Luer

NI-16-112-04

Tracheal Tube



Luer

NI-6-113-08

Tracheal Tube



Chevalier-Jackson

NI-16-114-04

Tracheal Tube outer tube closed inner
tube closed silver



Speaking Tube

NI-16-115-08

Speaking Tube



Moncorps

NI-17-101-14

Milium Knife
14 cm



Moncorps

NI-17-102-00

Spare Blade



Vidal

NI-17-103-14

Lupus Scraper
13 cm



Wolff

NI-17-105-01

Lupus Curette
14 cm



Kilner

NI-17-106-15

Skin Hooklet
14.5 cm



Gillies

NI-17-107-18

Skin Hooklet
18 cm



Kaye

NI-17-108-03

Face-lift Hook
13 cm

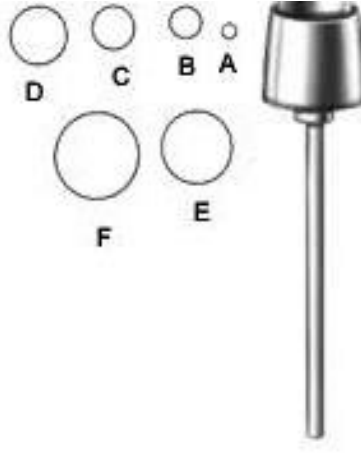

Dermal Punch

NI-17-109-02

Dermal Punch
5.5 cm



Handle

NI-17-110-00

Handle
8 cm

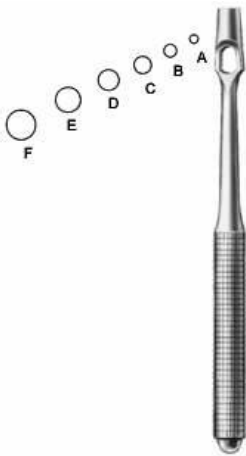

Keyes

NI-17-111-02

Dermal Punch
11 cm



Unna

NI-17-113-14

Comedone Extractor
14.5 cm



Saalfeld

NI-17-114-10

Comedone Extractor
11 cm



Saalfeld

NI-17-115-14

Saalfeld Comedone Extractor
14.5 cm



Schamberg

NI-17-116-10

Comedone Extractor
9.5 cm



Katsch

NI-17-117-14

Comedone Extractor
16 cm



Unna-Vidal

NI-17-118-11

Comedone Extractor
11.5 cm



D'Assump?

NI-17-119-15

Face-lift Forceps
18 cm



Gregory

NI-17-120-14

Face-lift Scissors
14 cm

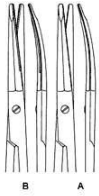

Kaye

NI-17-121-15
Face-lift Scissors
15 cm, 18 cm



Stella-S

NI-17-122-18
Face-lift Scissors
18 cm



Gorney

NI-17-123-18
Face-lift Scissors
18 cm

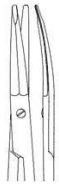

Freeman-Kaye

NI-17-124-18
Face-lift Scissors
18 cm



Freeman

NI-17-125-00
Face-lift Scissors
23 cm



Fox

NI-17-104-01
Lupus Curette
14 cm

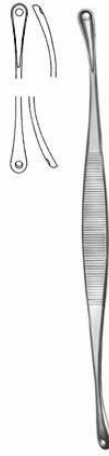

Unna

NI-17-112-14

Comedone Extractor

14.5 cm



Allis-Baby

NI-18-101-12

Intestinal and Tissue Grasping Forceps
13 cm

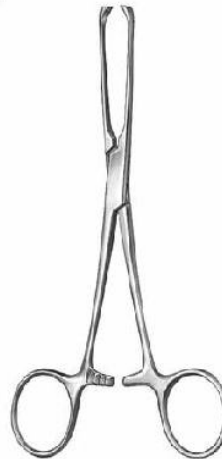
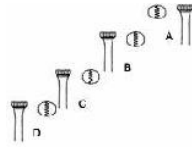

Allis

NI-18-102-15

Intestinal and Tissue Grasping Forceps
15.5 cm, 19 cm, 25.5 cm

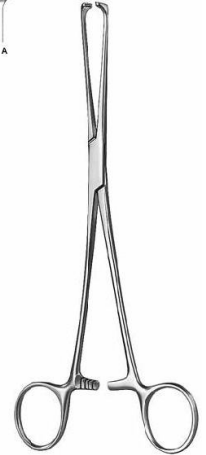
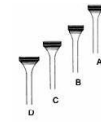

Allis

NI-18-103-16

Intestinal and Tissue Grasping Forceps
15.5 cm, 20 cm, 24.5 cm, 30 cm

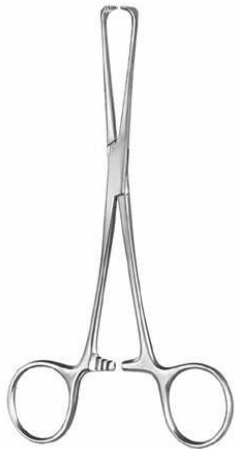

Allis-Adair

NI-18-104-15

Intestinal and Tissue Grasping Forceps
16 cm



Boys-Allis

NI-18-105-15

Intestinal and Tissue Grasping Forceps
15.5 cm



Thoms-Allis

NI-18-106-20

Intestinal and Tissue Grasping Forceps
20.5 cm



Allis

NI-18-107-20

Intestinal and Tissue Grasping Forceps
20 cm

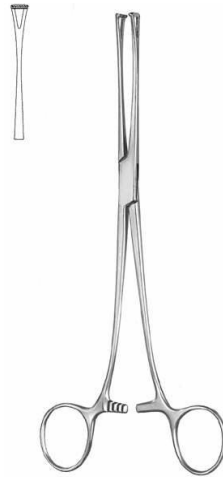

Lockwood

NI-18-108-20

Intestinal and Tissue Grasping Forceps
20 cm



Williams

NI-18-109-16

Intestinal and Tissue Grasping Forceps
16.5 cm

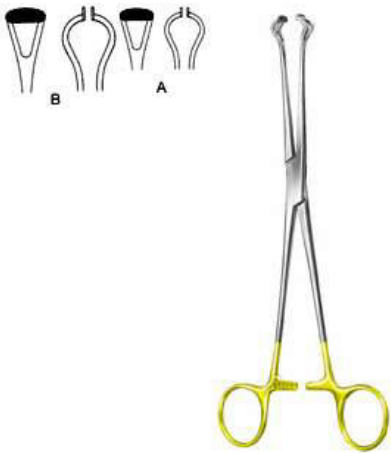

Babcock

NI-18-110-16

Intestinal and Tissue Grasping Forceps
16.5 cm, 21 cm

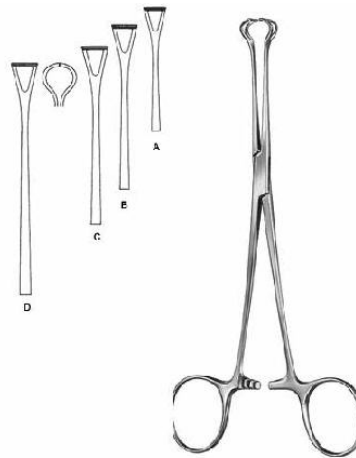

Babcock

NI-18-111-16

Intestinal and Tissue Grasping Forceps
15.5 cm, 17.5 cm, 21 cm, 24 cm

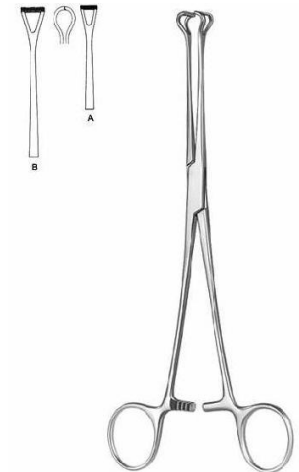

Babcock

NI-18-112-16

Intestinal and Tissue Grasping Forceps
16.5 cm, 25.5 cm



Duval

NI-18-113-20

Intestinal and Tissue Grasping Forceps
20.5 cm

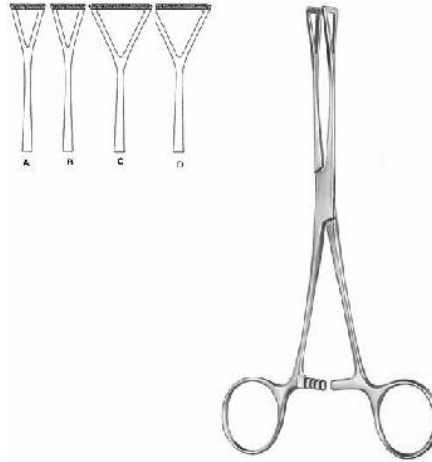

Duval

NI-18-114-18

Intestinal and Tissue Grasping Forceps
18 cm, 25.5 cm, 23 cm

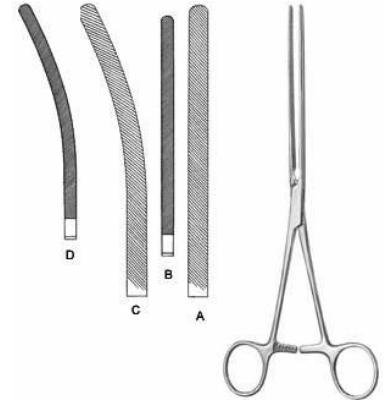

Doyen

NI-18-115-21

Intestinal Clamp
21.5 cm, 23.5 cm

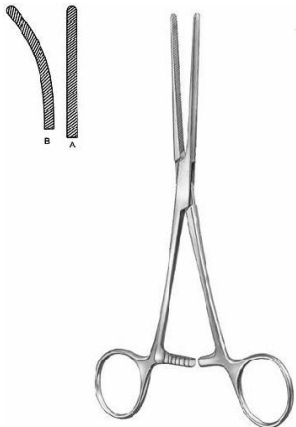

Doyen-Baby

NI-18-116-18

Intestinal Clamp
18 cm, 17.5 cm

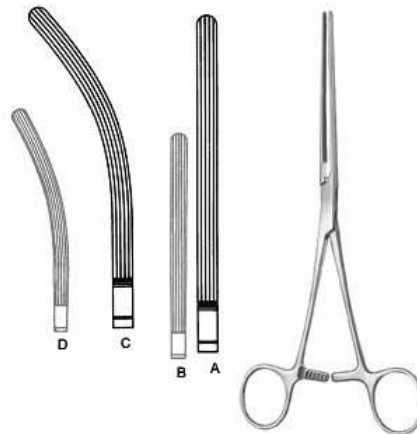

Mayo-Robson

NI-18-117-21

Intestinal Clamp
21.5 cm, 23.5 cm, 23 cm

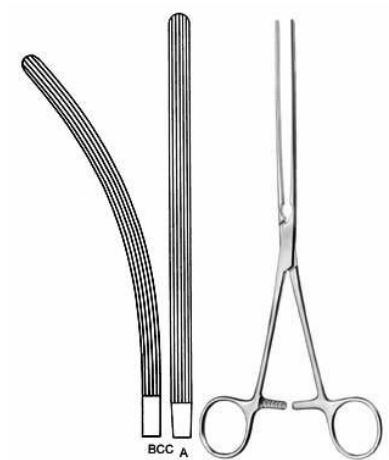

Mayo-Robson

NI-18-118-25

Intestinal Clamp
25.5 cm, 24.5 cm

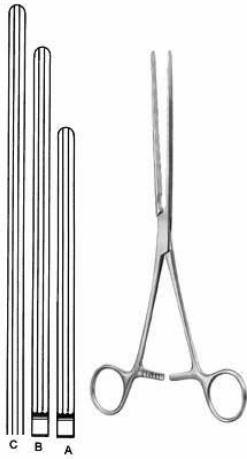

Kocher

NI-18-119-22

Intestinal Clamp

22.5 cm, 25 cm, 28.5 cm

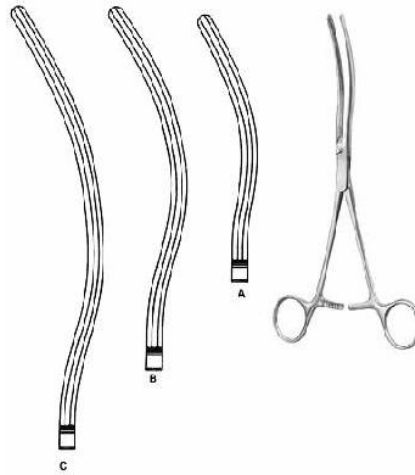

Kocher

NI-18-120-22

Intestinal Clamp

22 cm, 24.5 cm, 27.5 cm



Allen

NI-18-121-16

Intestinal Clamp

16 cm



Payr-Baby

NI-18-122-15

Intestinal and Pylorus Clamp

15 cm

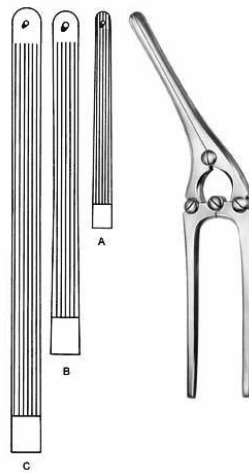

Payr

NI-18-123-21

Intestinal and Pylorus Clamp

20.5 cm, 29 cm, 34.5 cm



Stone-Watt

NI-18-124-07

Intestinal Anastomosis Clamp

8.5 cm, 10 cm



Stone-Watt
NI-18-125-15
Closing Forceps

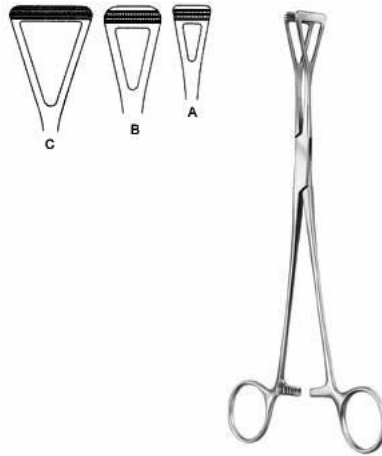

Scheibe
NI-18-126-18
Organ Grasping Forceps
18 cm

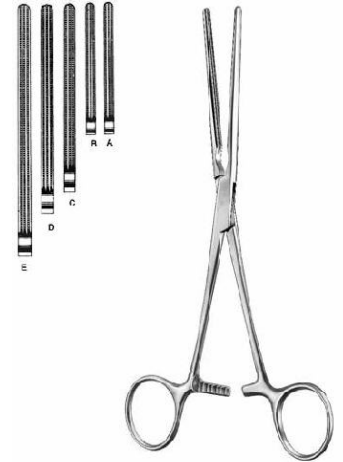

Doyen-Baby
NI-18-127-13
Intestinal Clamp
14 cm, 17 cm

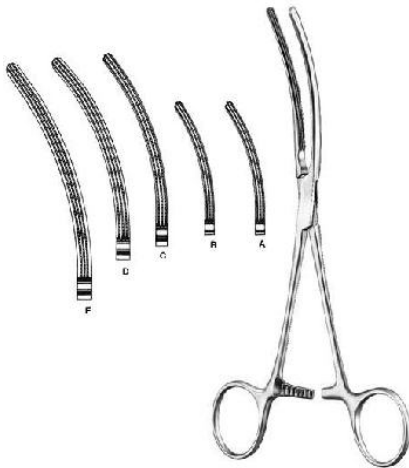

Doyen-Baby
NI-18-128-13
Intestinal Clamp
13.5 cm, 17 cm



Mayo-Robson
NI-18-129-25
Intestinal Clamp
26 cm



Mayo-Robson
NI-18-130-25
Intestinal Clamp
25 cm

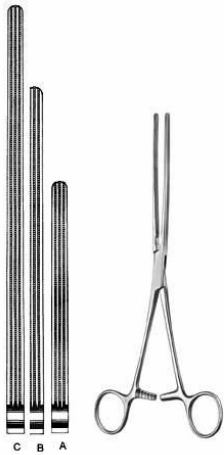

Kocher

NI-18-131-22

Intestinal Clamp
22.5 cm, 28 cm



Kocher

NI-18-132-22

Intestinal Clamp
22 cm, 25 cm, 27.5 cm

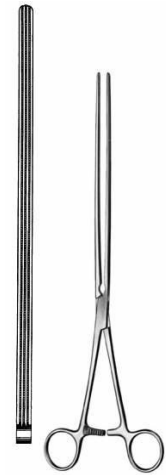

Scudder

NI-18-133-33

Intestinal Clamp
33.5 cm

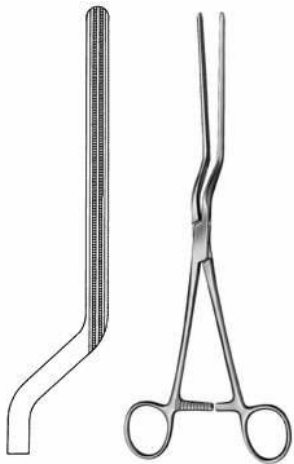

Brunner

NI-18-134-24

Sigmoid Anastomosis Forceps
27 cm

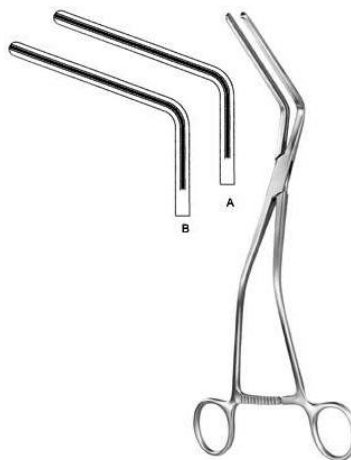

Hayes

NI-18-135-26

Sigmoid Anastomosis Forceps
27 cm, 28 cm



Veidenheimer

NI-18-136-23

Sigmoid Anastomosis Forceps
25 cm



Fehland

NI-18-137-24

Sigmoid Anastomosis Forceps
24 cm

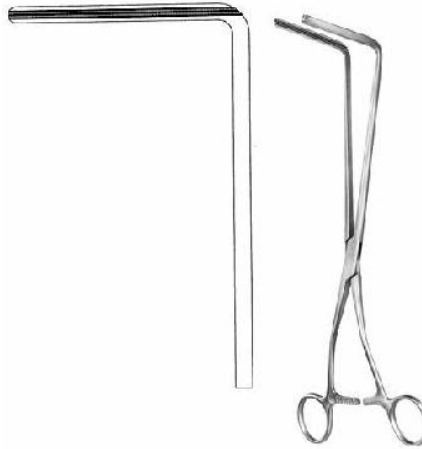

Resano

NI-18-138-30

Sigmoid Anastomosis Forceps
28 cm



Sims

NI-18-139-15

Rectal Speculum
15.5 cm



Sims

NI-18-140-15

Rectal Speculum
15.5 cm



Mathieu

NI-18-141-19

Rectal Speculum
19 cm



Alan-Parks

NI-18-142-00

Alan-Parks
14 cm

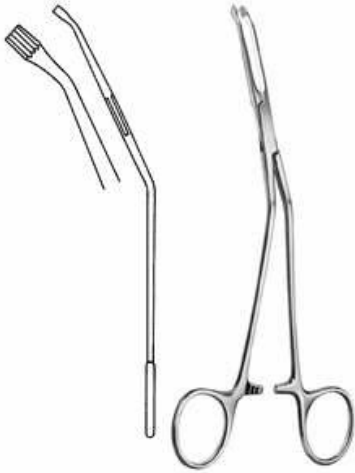

McGinvey

NI-18-143-19

Hemorrhoidal Grasping Forceps
19 cm



Handle For Biopsy Forceps

NI-18-144-00

Handle for biopsy forceps



Rectal Biopsy Forceps

NI-18-145-38

Rectal Biopsy Forceps

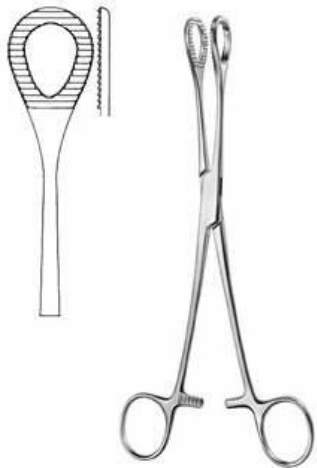

Heywood-Smith

NI-18-146-21

Polypus Grasping Forceps
21 cm

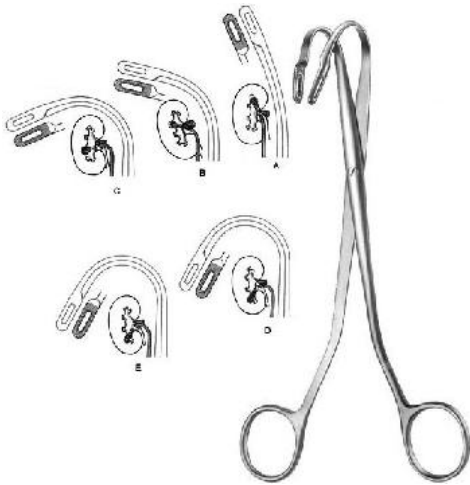

Randall

NI-19-101-23 A

Kidney Stone Forceps

23 cm Fig. 1 , 21 cm Fig. 2, 21 cm Fig. 3



Randall

NI-19-102-23 A

Kidney Stone Forceps

23 cm , 24.5 cm

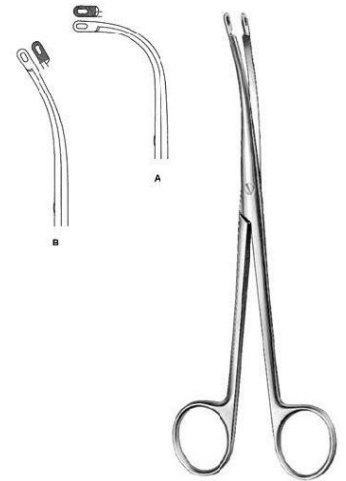

Heiming

NI-19-103-16 A

Kidney Stone Forceps

16 cm Fig. 1, 17 cm Fig. 2

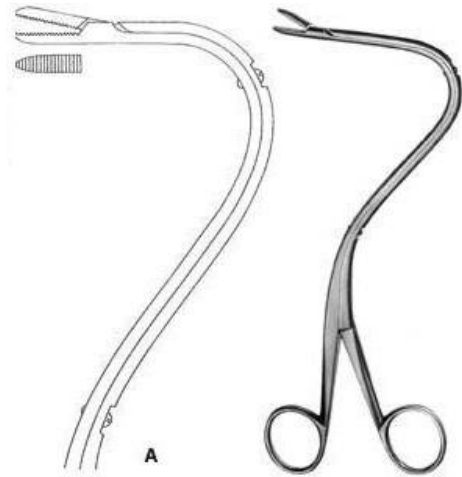

Elsasser

NI-19-104-01 A

Nephrostomy Forceps

21 cm Fig. 1 , 21 cm Fig. 2



Bakes

NI-19-105-01 A

Gall Duct Dilator

32 cm

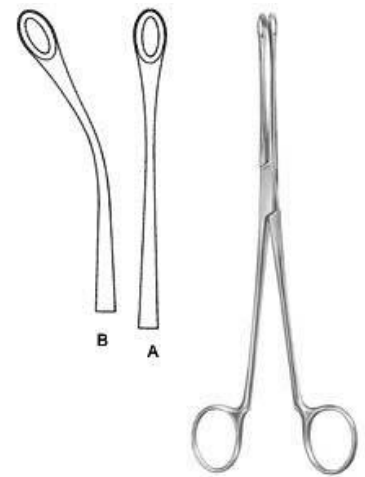

Blake

NI-19-106-20 A

Gall Stone Forceps

21 cm



Mayo-Blake

NI-19-107-20

Gall Stone Forceps
21 cm



Mayo-Blake

NI-19-108-20

Gall Stone Forceps
21 cm



Mixer

NI-19-109-22

Gall Stone Forceps
21.5 cm



Desjardins

NI-19-110-23 A

Gall Stone Forceps
23 cm

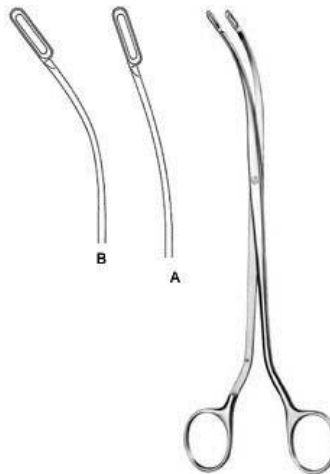

Desjardins

NI-19-111-24 A

Gall Stone Forceps



Luer-Korte

NI-19-112-01 A

Gall Stone Scoop
32 cm Fig. 0 , 32 cm Fig. 00 , 32 cm Fig. 000 , 32 cm Fig. 1, 32 cm Fig. 2, 32 cm Fig. 3, 32 cm Fig. 4

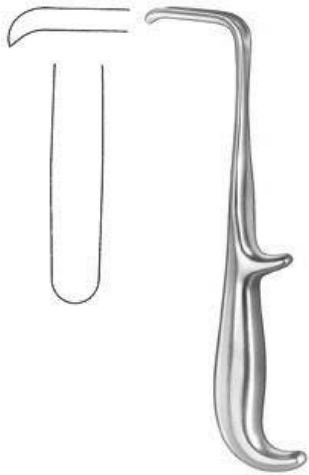

Young

NI-19-113-21

Prostatic Retractor
21.5 cm



Young

NI-19-114-22

Prostatic Retractor
20.5 cm



Young

NI-19-115-21

Prostatic Retractor
22 cm

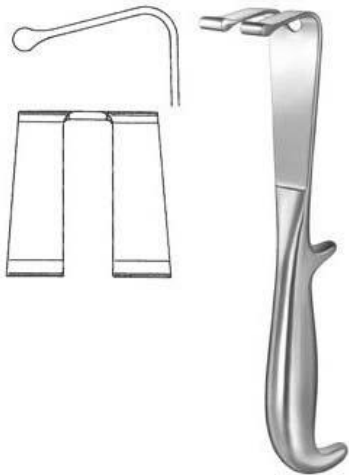

Young

NI-19-116-22

Prostatic Retractor
21.5 cm



Millin

NI-19-117-24

Capsule Forceps
24.5 cm

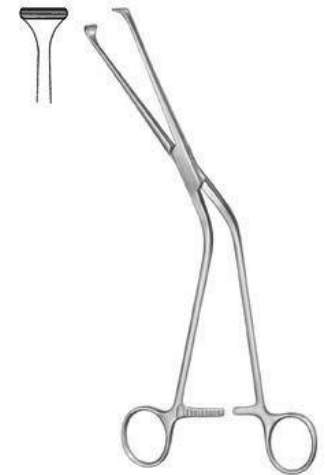

Millin

NI-19-118-24

Capsule Forceps
22 cm

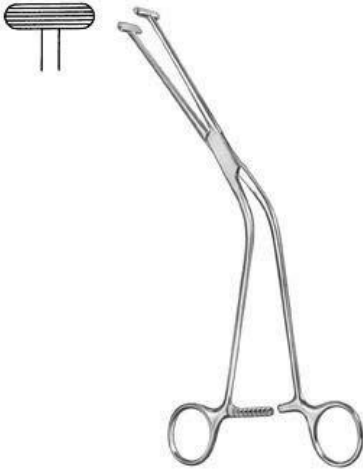

Millin

NI-19-119-23
Capsule Forceps
24.5 cm

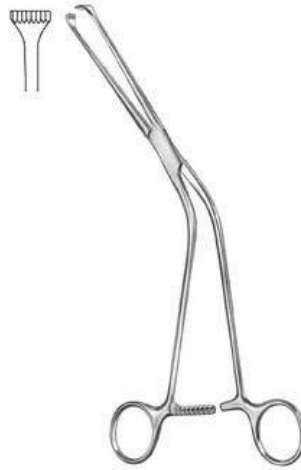

Millin

NI-19-120-23
Capsule Forceps
22 cm

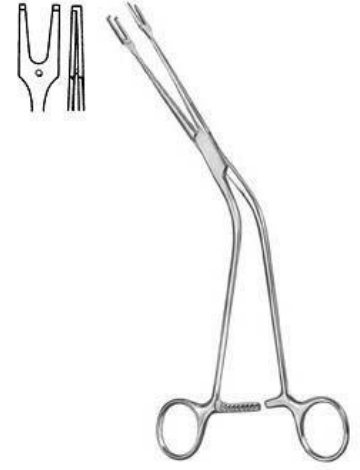

Millin

NI-19-121-24
Ligature Carrying Forceps
24.5 cm



Millin

NI-19-122-00
Bladder Neck Spreader
29



Thomson-Walker

NI-19-123-00
Bladder Retractor



Judd-Masson

NI-19-124-00
Bladder Retractor



Millin

NI-19-125-00 A

Bladder Retractor



Legueu

NI-19-126-27

Bladder Spatula
24 cm , 35 mm

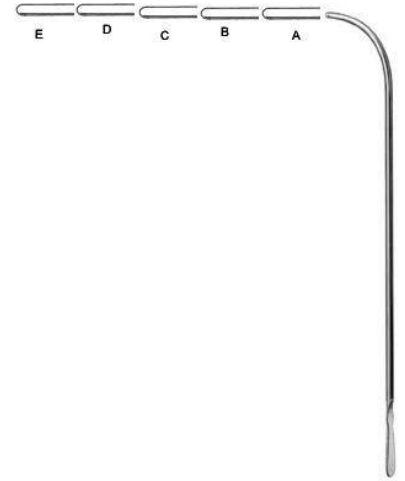

Van Buren

NI-19-127-00 A

Urethral Sound
27.5 cm

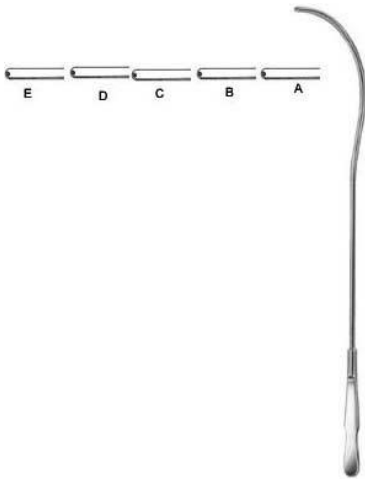

Guyon

NI-19-128-10 A

Urethral Sound
26 cm



Cusco

NI-20-101

Vaginal Speculum

75 x 32 mm, 85 x 35 mm



Cusco

NI-20-102-01

Vaginal Speculum

75 x 18 mm



Cusco

NI-20-103-01

Vaginal Speculum

80 x 22 mm, 100 x 25 mm , 105 x 27 mm



Cusco

NI-20-104-01

Vaginal Speculum

75 x 34 mm , 85 x 37 mm



Collin

NI-20-105-01

Vaginal Speculum

85 x 30 mm , 100 x 35 mm

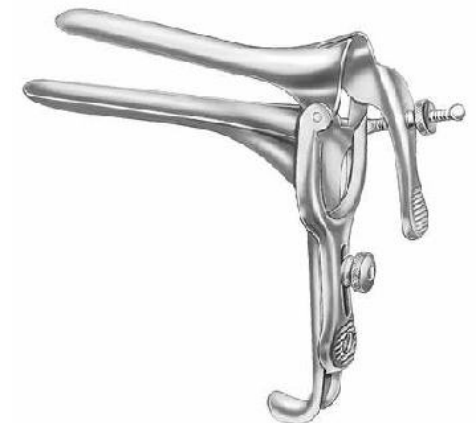

Pederson

NI-20-106-01

Vaginal Speculum

75 x 13 mm, 100 x 22 mm



Grave

NI-20-107-01

Vaginal Speculum
75 x 20 mm, 95 x 35 mm

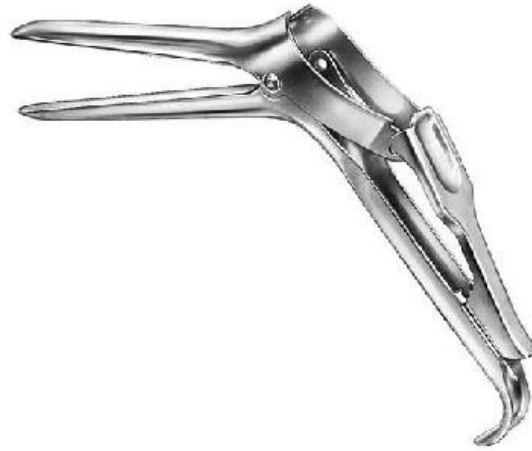

Semm

NI-20-108-01

Vaginal Speculum
100 x 20 mm, 105 x 27 mm



Sims

NI-20-109-01

Vaginal Speculum
65 x 25 mm, 70 x 30 mm



Kristeller

NI-20-110-01

Vaginal Speculum
70 x 27 mm



Kristeller

NI-20-111-01

Vaginal Retractor
75 x 23 mm



Kristeller

NI-20-112-01

Vaginal Speculum
Size 1



Kristeller

NI-20-113-01

Vaginal Speculum
105 x 18 mm



Kristeller

NI-20-114-01

Vaginal Retractor
110 x 14 mm



Kristeller

NI-20-115-01

Vaginal Speculum
Size 1

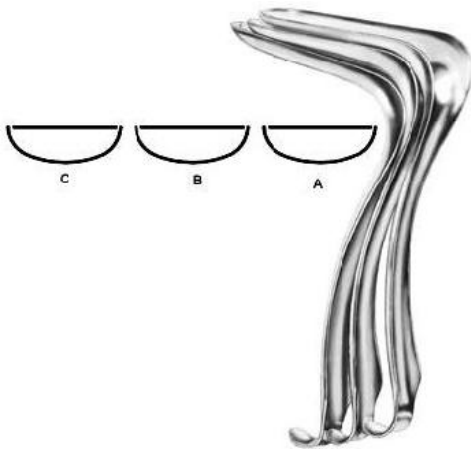

Kristeller

NI-20-116-01

Vaginal Speculum
105 x 26 mm

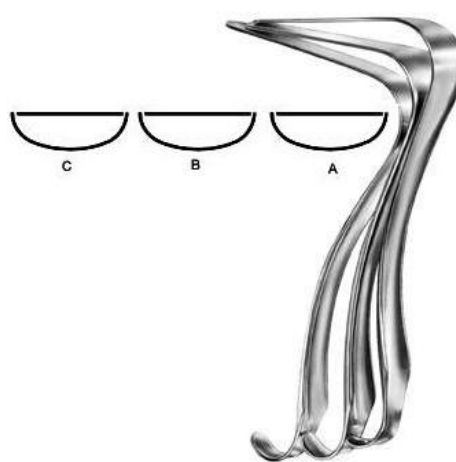

Kristeller

NI-20-117-01

Vaginal Retractor
115 x 22 mm, 115 x 23 mm



Kristeller

NI-20-118-01

Vaginal Speculum
Size 1

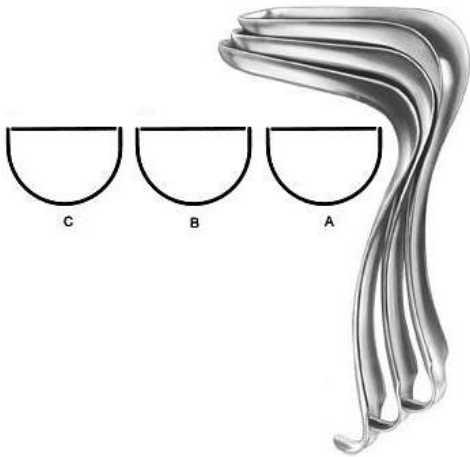

Kristeller

NI-20-119-01

Vaginal Speculum
110 x 27 mm

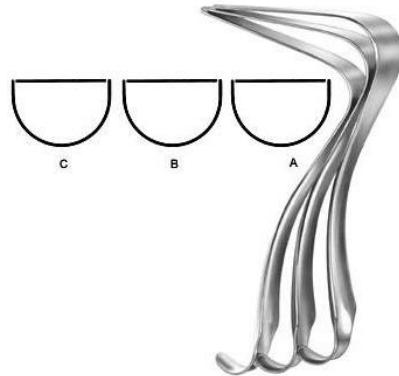

Kristeller

NI-20-120-01

Vaginal Retractor
115 x 23 mm



Kallmorgen

NI-20-121-01

Vaginal Speculum



Kallmorgen

NI-20-122-01

Vaginal Retractor
70 x 40 mm Fig. 1, 90 x 40 mm Fig. 2



Kallmorgen

NI-20-123-01

Vaginal Speculum
70 x 33 mm, 90 x 33 mm

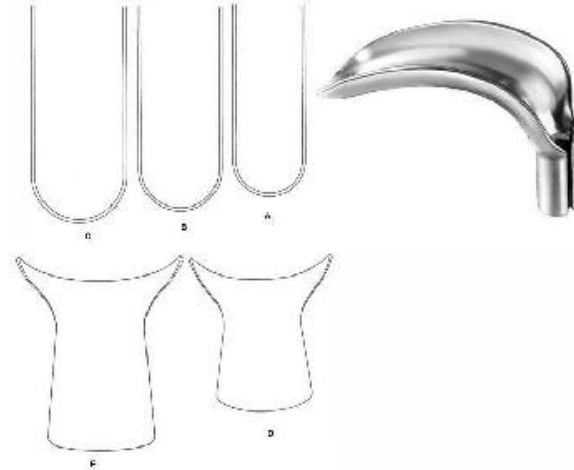

Scherbak

NI-20-125-00

Vaginal Speculum
Size 1



Auvard

NI-20-126-22

Vaginal Speculum
80 x 43 mm



Weissbarth

NI-20-127-24

Vaginal Speculum
21 cm 80 x 42 mm



Breisky

NI-20-128-20

Vaginal Speculum
29 cm 100 x 20 mm, 29 cm 100 x 25 mm



Kogan

NI-20-129-24

Endocervical Speculum
25 cm 70 x 30 mm



Kogan

NI-20-130-24

Endocervical Speculum
24.5 cm



Hegar

NI-20-131-24

Uterine Dilator
18.5 cm 1,0



Hegar

NI-20-132-02
Uterine Dilator
20 cm 1,0



Hank

NI-20-133-10
Uterine Dilator
26.5 cm Fig. 9/10



Sims

NI-20-134-32
Uterine Sound
33 cm



Valleix

NI-20-135-25
Uterine Sound
29.5 cm



Braun

NI-20-136-26
Uterine Depressor
27.5 cm



Schroder

NI-20-137-25
Uterine Tenaculum Forceps
25.5 cm



Braun

NI-20-138-25

Uterine Tenaculum Forceps
26 cm



Duplay

NI-20-139-28

Uterine Tenaculum Forceps
25.5 cm



Beacham

NI-20-140-26

Amniotome
26 cm



Skene

NI-20-141-24

Uterine Tenaculum Forceps
24 cm

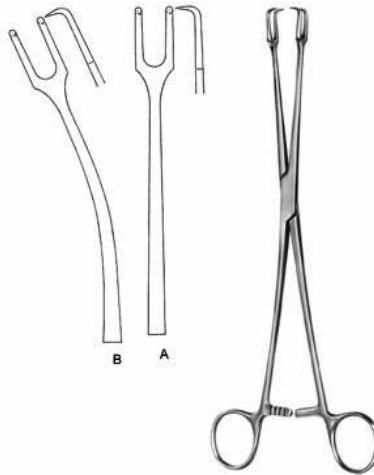

Schroder

NI-20-142-24

Uterine Tenaculum Forceps
25 cm



Teale

NI-20-143-23

Uterine Tenaculum Forceps
23.5 cm

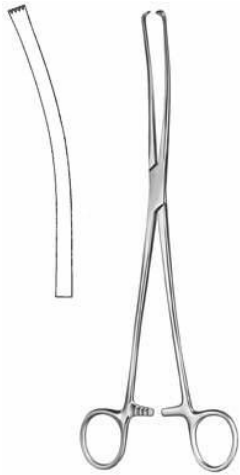

Iowa

NI-20-144-26

Uterine Tenaculum Forceps
26 cm

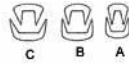

Museux

NI-20-145-24

Uterine Tenaculum Forceps
24 cm



Jacobs

NI-20-146-21

Uterine Tenaculum Forceps
21 cm

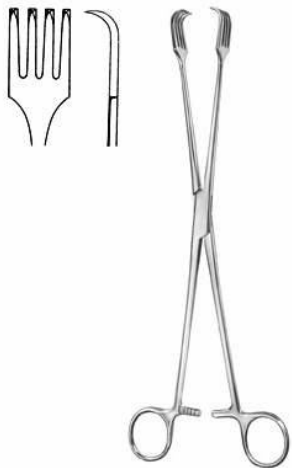

Uterine Tenaculum Forcep

NI-20-147-26

Uterine Tenaculum Forcep
26.5 cm



Braun

NI-20-148-16

Uterine Tenaculum Forceps
16 cm

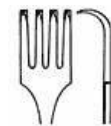

Czerny

NI-20-149-21

Uterine Tenaculum Forceps
21 cm



Kelly

NI-20-150-32

Uterine Polypus Forceps
32 cm



Noto

NI-20-151-27

Uterine Polypus Forceps
27 cm

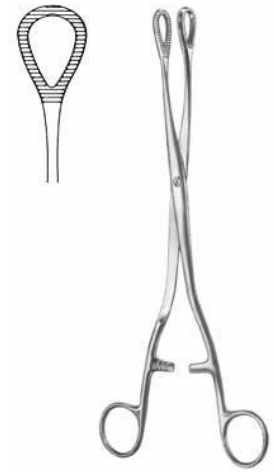

Heywood-Smith

NI-20-152-25

Uterine Polypus Forceps
25 cm

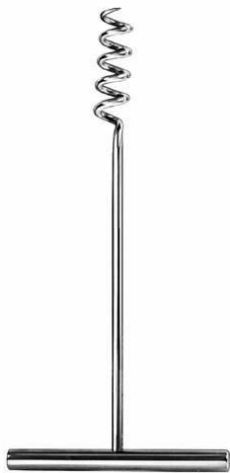

Doyen

NI-20-153-17

Myoma Screw
17 cm



Doyen

NI-20-154-17

Myoma Screw
14.5 cm



Segond

NI-20-155-27

Myoma Knife
28 cm

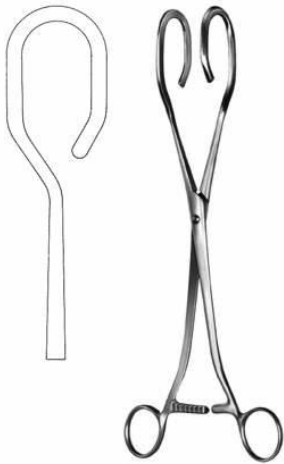

Dartigues

NI-20-156-27

Uterine Seizing Forceps



Somer

NI-20-157-27

Uterine Seizing Forceps
22.5 cm



Collin

NI-20-158-25

Uterine Seizing Forceps jaw 40 mm wide
26 cm

28 cm



Ayre

NI-20-159-23

Conization Knife cutting edge 3,6 mm
wide
23.5 cm



Emmett

NI-20-160-03

Fistula Hook
22 cm Fig.3



Simon

NI-20-161-22

Fistula Hook
21.5 cm



Simon

NI-20-162-22

Fistula Hook
21.5 cm



Novak

NI-20-163-23

Suction Curette 4 mm ?
24.5 cm



Kevorkian

NI-20-164-23

Uterine Biopsy Curette 6,0 mm ?
30 cm



Munchen

NI-20-165-27

Uterine Biopsy Curette 4,8 mm ?
27 cm



Gellhorn

NI-20-166-23

Uterine Biopsy Forceps jaw 8,6 mm wide
24 cm



Faure

NI-20-167-21

Faure Uterine Biopsy Forceps
21 cm

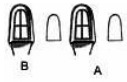

Schubert

NI-20-168-21

Uterine Biopsy Forceps jaw 4,8 mm wide
21.5 cm, 28 cm

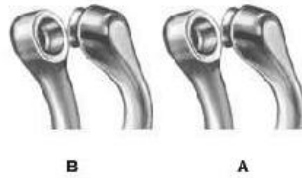

Thoms-Gaylor

NI-20-169-22

Uterine Biopsy Forceps jaw 5,6 mm ?
21 cm, 23.5 cm

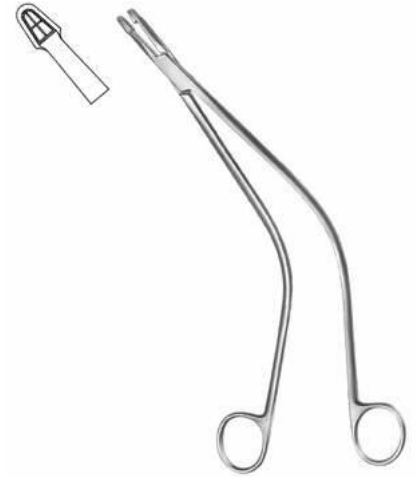

Schubert

NI-20-170-26

Schubert Uterine Biopsy Forceps
25.5 cm

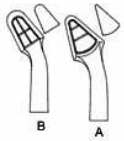

Van Doren

NI-20-171-24

Uterine Biopsy Forceps jaw 4,9 mm wide
27 cm, 25.5 cm



Alexander

NI-20-172-28

Uterine Biopsy Forceps jaw 5,1 mm wide
28 cm



Kevorkian

NI-20-173-32

Uterine Biopsy Forceps
25 cm

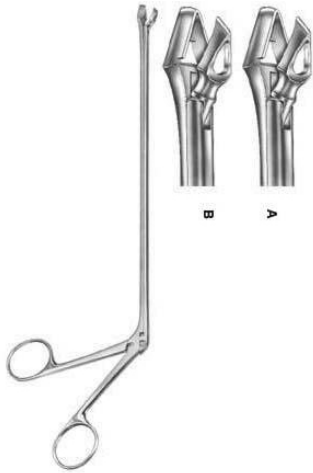

Schumacher

NI-20-174-01

Uterine Biopsy Forceps jaw 4,6 / 5,4 mm wide
24 cm



Schumacher

NI-20-175-00

Uterine Biopsy Forceps
25 cm



IUP Grasping Forceps 3 Mm ?

NI-20-176-22

IUP Grasping Forceps 3 mm ?
22 cm

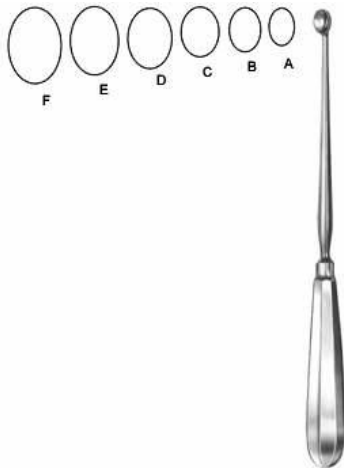

Simon

NI-20-177-01

Uterine Scoop
24.5 cm 9,8 x 8,6 mm, 24.5 cm 11,6 x 8,3 mm



Simon

NI-20-178-01

Uterine Scoop
30 cm 9,8 x 8,6 mm, 30 cm 11,6 x 8,3 mm



Recamier

NI-20-179-05

Uterine Curette
31 cm Fig. 00 5 mm, 31 cm Fig. 0 6 mm



Recamier

NI-20-180-05

Uterine Curette

31 cm Fig. 00 5 mm, 31 cm Fig. 0 6 mm



Sims

NI-20-181-05

Uterine Curette

31 cm Fig. 00 5 mm, 31 cm Fig. 0 6 mm

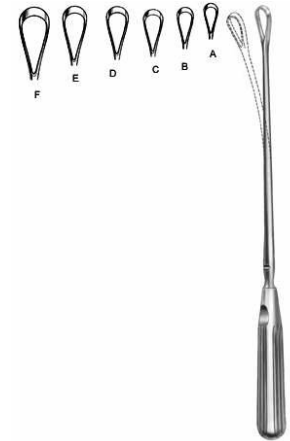

Sims

NI-20-182-05

Uterine Curette

31 cm Fig. 00 5 mm, 31 cm Fig. 0 6 mm

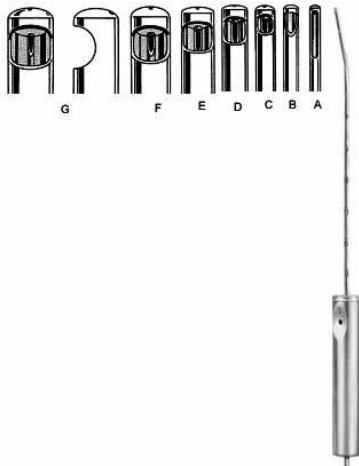

Suction Curette

NI-0-183-03

Suction Curette

29 cm 3,0 mm ?, 29 cm 4,5 mm ?, 29 cm 6,0 mm ?



Martin

NI-21-101-34

Pelvimeter cm, inch scale
34 cm



Nagele

NI-5-102-36

Obstetrical Forceps
35 cm, 40.5 cm



Simpson

NI-5-103-30

Obstetrical Forceps
31 cm



Wrigley

NI-5-104-28

Obstetrical Forceps
28 cm



Simpson

NI-21-105-36

Obstetrical Forceps
36.5 cm



Kielland

NI-21-106-41

Obstetrical Forceps
42 cm

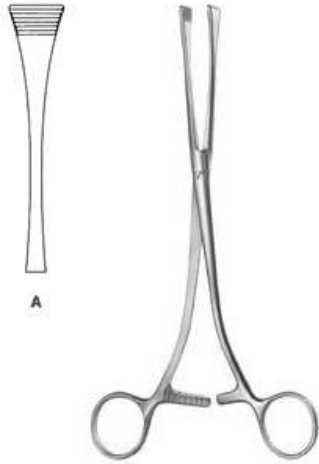

Green-Armytage

NI-21-107-21

Uterine Clamp
21 cm



Sellheim

NI-21-108-28

Obstetrical Lever
32 cm

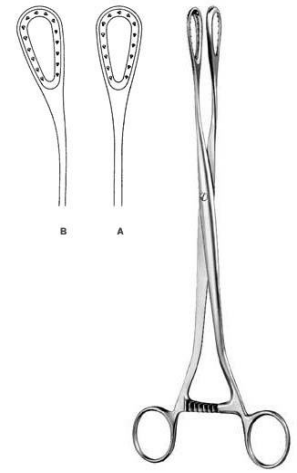

Sanger

NI-21-109-27

Placenta and Ovum Forceps
27.5 cm, 27 cm

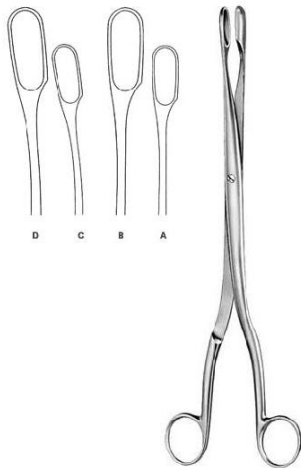

Winter

NI-21-110-01

Placenta and Ovum Forceps
28 cm Fig. 1, 28 cm Fig. 2

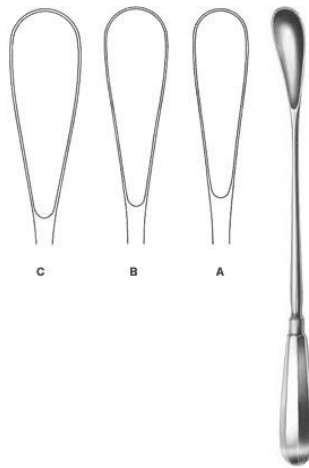

Cuzzi

NI-21-111-01

Placenta Scoop
30 cm 14,5 mm, 30 cm 18 mm



Pestalozza

NI-21-112-30

Placenta Scoop
30 cm



Kane

NI-21-113-08

Umbilical Cord Clamp
8.5 cm



Collin

NI-21-114-09

Umbilical Cord Clamp
8.5 cm



Irrigator

NI-23-101-10

Sterilization
Size 1



Round Bowl

NI-23-102-16

Sterilization
220 mm x 70 mm, 400 mm x 150 mm



Round Bowl

NI-23-103-33

Sterilization
? x h 6,00 l



Flat Dish

NI-23-104-11

Sterilization
? x h 0,20 l



Lid Only

NI-23-105-11

Sterilization
Size 1



Stainless Steel

NI-23-106-04

Sterilization
? x h 0,30 l



Round Dish

NI-23-107-11

Sterilization

? x h 0,30 l, ? 128 x 38 mm 0,40 l



Flat Dish

NI-23-108-11

Sterilization

? x h 0,15 l



Measurer

NI-23-109-01

Graduated inside

100cc = 0,1 l



Measurer

NI-23-110-02

Graduated Inside

0,25 l, 0,50 l



Petri Dish

NI-23-111-10

with Lid ? x h



Petri Dish

NI-23-112-09

without lid ? x h

Size 1



Lid For Petri Dishes

NI-23-113-10
Sterilization
Size 1



Universal Tray

NI-23-114-23
Sterilization
l x b x h



Instrument Tray

NI-23-115-21
Sterilization
l x b x h



Universal Tray

NI-23-116-23
Sterilization
l x b x h



Round Bowl

NI-23-117-22
Sterilization
? x h



Metal Jar

NI-23-118-30
Sterilization
? 30mm x 90 mm, ? 50mm x 100 mm



Instrument Box

NI-23-119-16

lid with knob
l x b x h



Instrument Box

NI-23-120-16

lid with knob
l x b x h



Instrument Box

NI-23-121-20

Sterilization
l x b x h



Round Metal Box

NI-23-122-06

Sterilization
? 75 mm x 75 mm, ? 100 mm x 60 mm



Medicine Cup Graduated Inside

NI-23-123-25

Sterilization
25 cm



Medicine Cup Graduated Inside

NI-23-124-50

Sterilization
50 cm



Tablet Tray

NI-23-125-75

Sterilization
? 75 mm x 12 mm



Metal Cup

NI-23-126-90

Sterilization
? 90 mm x 90 mm



Denture Cup

NI-23-127-75

Sterilization
? 75 mm x 50 mm



Insert For Cup

NI-23-128-75

Sterilization
? 73 mm x 75 mm



Kidney Dish

NI-23-129-17

Kidney Dish
l x b x h



Placenta Pan

NI-23-130-36

Sterilization
Size 1



Waste Cotton Collector

NI-23-131-01

Sterilization
? 50 mm x 75 mm



Spirit Lamp

NI-23-132-07

Sterilization
120 cm



Charri?Re

NI-7-102-35

Amputation Saw
35 cm



Langenbeck

NI-7-103-23

Amputation Saw
24.5 cm



Charriere

NI-7-104-27

Amputation Saw
26.5 cm



Reamer

NI-7-105-14

Reamer
13.5 cm



Perthes

NI-7-106-18

Reamer
18 cm



Perthes

NI-7-107-21

Reamer
21.5 cm



Reamer

NI-7-108-14

Reamer
14 cm



Flat Trephine

NI-7-111-18

Flat Trephine

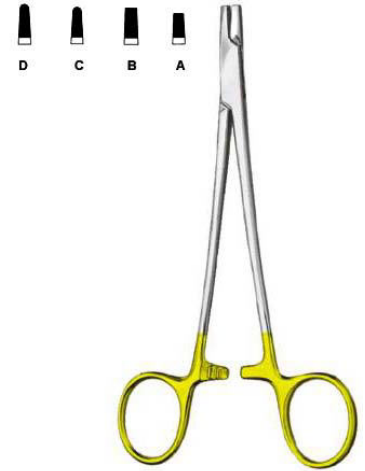

Wire Twisting Forceps

NI-7-112-01

Wire Twisting Forceps
15.5 cm, 18 cm, 20 cm

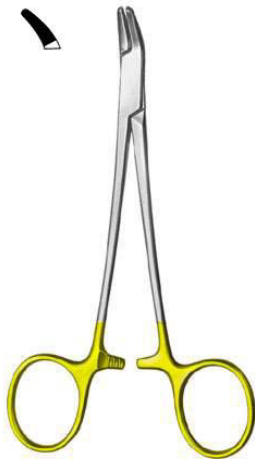

Wire Twisting Forceps

NI-7-113-15

Wire Twisting Forceps
15.5 cm



Flat Nose Plier

NI-7-114-17

Flat Nose Plier
18.5 cm



Wire Twisting Forceps

NI-7-115-18

Wire Twisting Forceps
19 cm



Combi-Flat Nose Plier

NI-7-116-15

Combi-Flat Nose Plier
15 cm

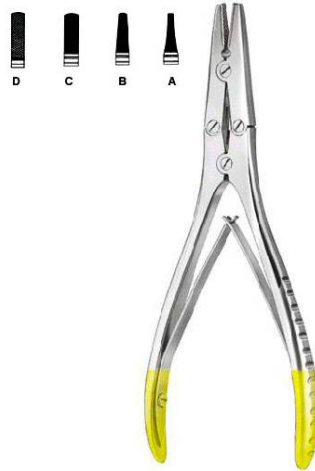

Flat Nose Plier

NI-7-117-01

Flat Nose Plier
18 cm

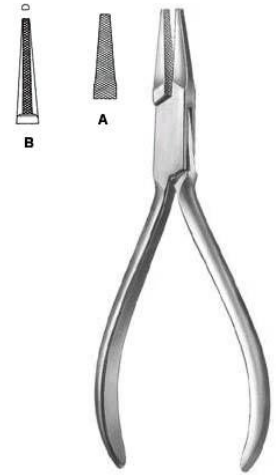

Flat Nose Plier

NI-7-118-14

Flat Nose Plier
13.5 cm



Hackstock

NI-7-119-16

Flat Nose Plier
16 cm

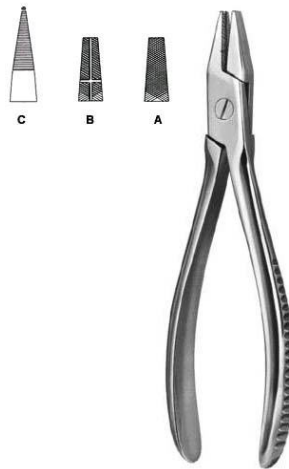

Flat Nose Plier

NI-7-120-01

Flat Nose Plier
17.5 cm



Wire Cutting Pliers

NI-7-121-18

Wire Cutting Pliers
18.5 cm



Wire Cutting Pliers

NI-7-122-15

Wire Cutting Pliers
15 cm



Wire Cutting Pliers

NI-7-123-18

Wire Cutting Pliers
17.5 cm

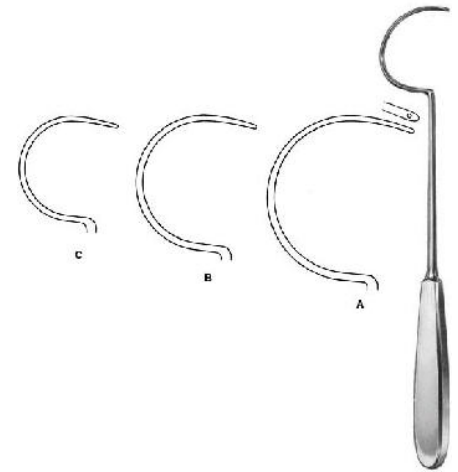

Demel

NI-7-124-18

Wire Guide
28 cm Fig. 3 , 29 cm Fig. 2 , 31 cm Fig. 1

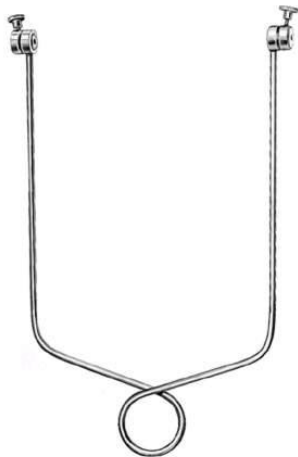

Bohler

NI-7-125-15

Extension Bow



Kirschner

NI-7-126-01

Extension Bow
18.5 cm , 26.5 cm



Traction Hook For Extension Bows

NI-7-127-06

Traction Hook for Extension Bows



Kirschner
NI-7-128-06
Wire Drill
6 cm, 12 cm



Kirschner
NI-7-129-06
Wire Drill
14 cm, 16 cm



Kirschner
NI-7-130-10
Wire Drill
31 cm



Kirschner
NI-7-131-10
Wire Drill
12 cm, 16 cm, 18 cm



Kirschner
NI-7-132-10
Wire Drill
31 cm



Buckley
NI-7-133-02
Chisel
16 cm



Buckley

NI-7-134-02

Gouge
16 cm



Stout

NI-7-135-03

Bone Chisel
21 cm



Bone Chisel

NI-7-112-01

Bone Chisel
18 cm



Bone Chisel

NI-7-137-04

Bone Chisel
18 cm



Bone Chisel

NI-138-04

Bone Chisel
17 cm



Bone Chisel

NI-7-139-04

Bone Chisel
17 cm

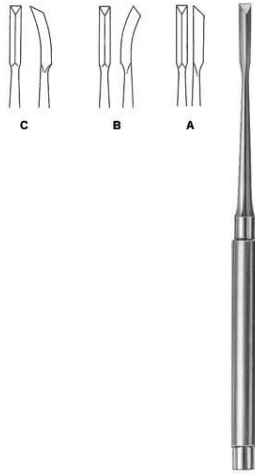

Gardner

NI-7-112-01

Bone Chisel

17 cm 4mm



Snyder-O.S.U

NI-7-141-03

Bone Chisel

16.5 cm 3mm , 16.5 cm 5.5mm



O.S.U.

NI-7-142-01

one Chisel

17 cm 7mm



O.S.U.

NI-7-143-01

one Chisel

17 cm 9mm



Osteotome

NI-7-144-08

Osteotome

13.5 cm 8mm , 13.5 cm 10mm , 13.5 cm 12mm , 13.5 cm 14mm , 13.5 cm 16mm

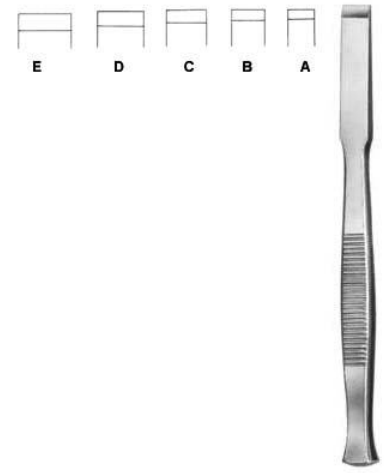

Chisel

NI-7-145-08

Chisel

13.5 cm 8mm , 13.5 cm 10mm , 13.5 cm 12mm , 13.5 cm 14mm , 13.5 cm 16mm



Gouge

NI-7-146-08

Gouge

13.5 cm 8mm , 13.5 cm 10mm , 13.5 cm 12mm , 13.5 cm 14mm , 13.5 cm 16mm



Partsch

NI-7-147-02

Chisel

13.5 cm 2mm, 13.5 cm 3mm , 13.5 cm 4mm , 13.5 cm 5mm , 13.5 cm 6mm , 17 cm 2mm , 17 cm 3mm , 17 cm 4mm , 17 cm 5mm , 17 cm 6mm



Partsch

NI-7-148-02

Gouge

13.5 cm 2mm, 13.5 cm 3mm , 17 cm 2mm , 17 cm 3mm

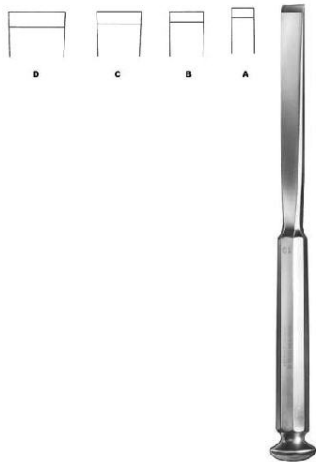

Stille

NI--7-149

Chisel

20 cm 10mm , 20 cm 15mm , 20 cm 20mm , 20 cm 25mm



Stille

NI--7-150

Osteotome

20 cm 10mm , 20 cm 15mm , 20 cm 20mm , 20 cm 25mm



Stille

NI-7-151-10

Gouges

20 cm 10mm , 20 cm 15mm , 20 cm 20mm , 20 cm 25mm



Lambotte, Mini

NI-7-152-02

Osteotome

12.5 cm 2mm , 12.5 cm 3mm , 12.5 cm 4mm , 12.5 cm 6mm



Lambotte

NI-7-153-15

Osteotome

24 cm 15mm , 24 cm 20mm , 24 cm 25mm , 24 cm 30mm



Lambotte

NI-7-154-15

Osteotome

24 cm 15mm , 24 cm 20mm , 24 cm 25mm , 24 cm 30mm



Smith-Petersen

NI-7-155-06

Osteotome

20.5 cm 6mm , 20.5 cm 9mm , 20.5 cm 13mm



Smith-Petersen

NI-7-156-06

Osteotome

20.5 cm 6mm , 20.5 cm 9mm , 20.5 cm 13mm , 20.5 cm 16mm , 20.5 cm 19mm



Smith-Petersen

NI-7-157-09

Gouge

20.5 cm 9mm , 20.5 cm 14mm , 20.5 cm 19mm , 20.5 cm 25mm



Smith-Petersen

NI-7-158-09

Gouge

20.5 cm 9mm , 20.5 cm 14mm , 20.5 cm 19mm



Hoke

NI-7-159-03

Osteotome

17 cm 3mm , 17 cm 5mm , 17 cm 6mm , 17 cm 8mm

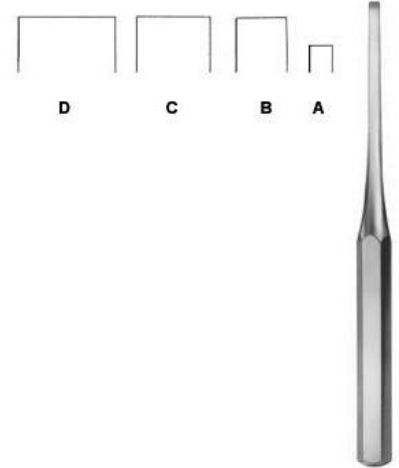

Hibbs

NI-7-151-10

Osteotome

24.5 cm 6mm , 24.5 cm 13mm , 24.5 cm 19mm

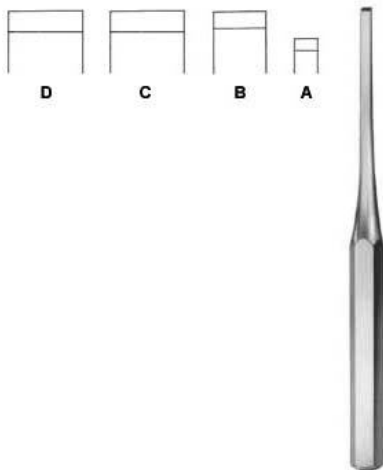

Hibbs

NI-7-161-06

Chisel

24.5 cm 6mm , 24.5 cm 13mm , 24.5 cm 19mm

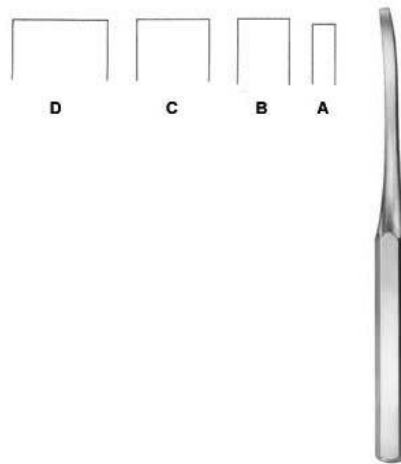

Hibbs

NI-7-162-06

Osteotome

24.5 cm 6mm , 24.5 cm 13mm , 24.5 cm 19mm

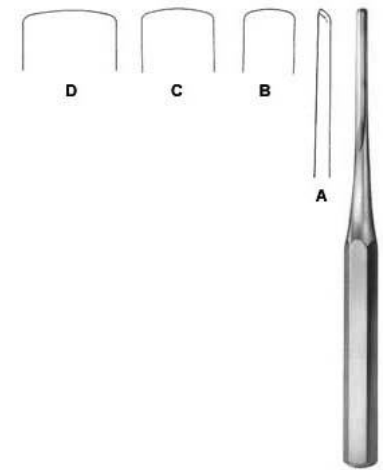

Hibbs

NI-7-163-06

Hibbs

24.5 cm 6mm , 24.5 cm 13mm , 24.5 cm 19mm



Hibbs

NI-7-164-06

Gouge
24.5 cm 6mm , 24.5 cm 13mm , 24.5 cm
19mm

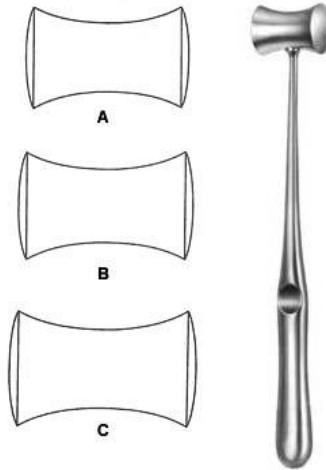

Williger

NI-7-165-01

Mallet
24 cm

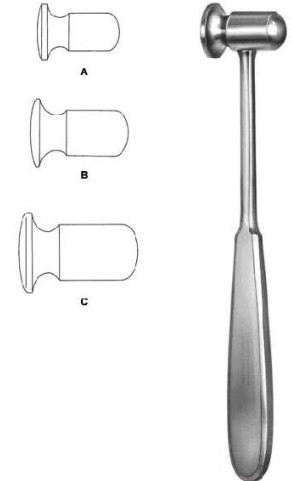

Doyen

NI-7-166-01

Mallet
20.5 cm, 21 cm, 21.5 cm



Collin

NI-7-151-10

Mallet
20 cm

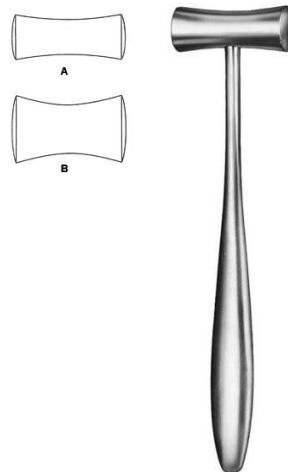

Lucae

NI-7-168-01

Mallet
19.5 cm



Cottle

NI-7-169-19

Mallet
19 cm



Williger

NI-7-170-01

Mallet

16.5 cm



Mead

NI-7-171-17

Mallet

19 cm



Partsch

NI-7-172-18

Mallet

19 cm



Schede

NI-7-173-01

Bone Curette Fig. 0 to 4

17 cm



Kahre-Williger

NI-7-201-04

Periosteal Elevator

4 mm, 5 mm, 7 mm



Periosteal Elevator

NI-7-202-06

Periosteal Elevator

17 cm 6mm , 17 cm 8mm



Volkmann

NI-7-174-01

Bone Curette

17 cm Fig. 0, 17 cm Fig. 00, 17 cm Fig. 000, 17 cm Fig. 1, 17 cm Fig. 2, 17.5 cm Fig. 3, 17.5 cm Fig. 4



Doyen

NI-7-203-17

Rib Raspatory

17.5 cm

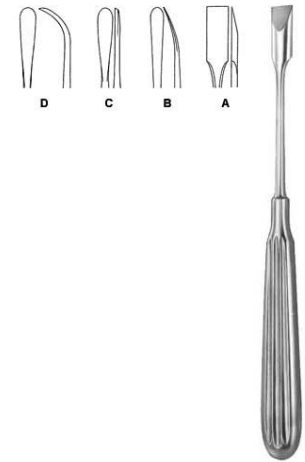

West

NI-7-204-19

Periosteal Elevator, double-ended

17 cm, 17.5 cm



Bruns

NI-7-175-01

Bone Curette

17 cm Fig. 0, 17 cm Fig. 00, 17 cm Fig. 000, 17 cm Fig. 1, 17 cm Fig. 2, 17 cm Fig. 3, 17 cm Fig. 4

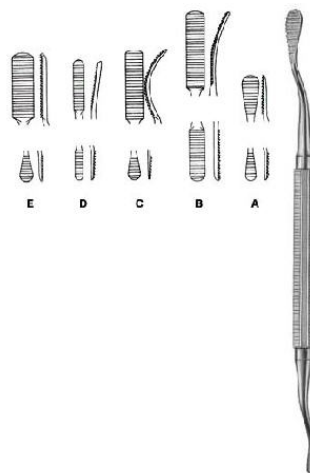

Miller-Colburn

NI-7-209-01

Bone File

18 cm Fig. 1, 18 cm Fig. 2, 18 cm Fig. 3, 18 cm Fig. 4, 18 cm Fig. 5



Spratt

NI-7-175-01

Bone Curette

17 cm Fig. 0, 17 cm Fig. 00, 17 cm Fig. 000, 17 cm Fig. 0000, 17 cm Fig. 1, 17 cm Fig. 2, 17 cm Fig. 3, 17 cm Fig. 4, 17 cm Fig. 5

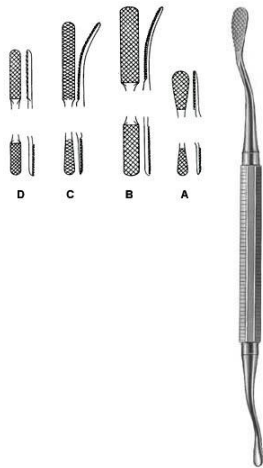

Miller-Colburn

NI-7-210-01

Bone File

18 cm Fig. 1, 18 cm Fig. 2, 18 cm Fig. 3, 18 cm Fig. 4



Langenbeck

NI-7-211-20

Elevator



Bruns

NI-7-177-01

Bone Curette

23 cm Fig. 0, 23 cm Fig. 00, 23 cm Fig. 000, 23 cm Fig. 1, 23 cm Fig. 2, 23 cm Fig. 3

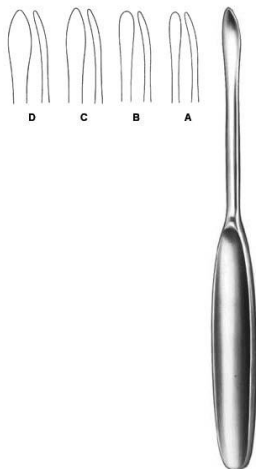

Martin-Langenbeck

NI-7-212-01

Elevator

17 cm 5mm, 17 cm 7mm, 17 cm 8mm



Scoville

NI-7-178-25

Bone Curette

25 cm



Vickers

NI-7-213-17

Elevator

17 cm



Vickers
NI-7-214-17
Dissector
17 cm

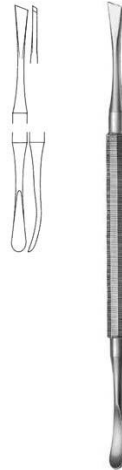

Simon
NI-7-179-01
Bone Curette



Williger
NI-7-215-17
Elevator
16.5 cm 5.5mm

25 cm Fig. 1 , 25 cm Fig. 2 , 25 cm Fig. 3 ,
25 cm Fig. 4 , 25 cm Fig. 5



Modell USA
NI-7-180-01
Bone Curette

16 cm Fig. 1, 16 cm Fig. 2, 16 cm Fig. 3, 16
cm Fig. 4



Williger
NI-7-216-16
Elevator
16.5 cm 5.5mm



Mead
NI-7-217-17
Mallet
19 cm



Periosteal Elevator

NI-7-218-18

Periosteal Elevator



Hohmann

NI-7-219-43

Bone Lever
23.5 cm



Modell USA

NI-7-181-01

Bone Curette

15.5 cm Fig. 1 , 15.5 cm Fig. 2 , 15.5 cm Fig. 3 , 15.5 cm Fig. 4



Lempert

NI-7-220-19

Bone Rongeur
19 cm



Modell USA

NI-7-182-01

Bone Curette

15.5 cm Fig. 1 , 15.5 cm Fig. 2 , 15.5 cm Fig. 3 , 15.5 cm Fig. 4

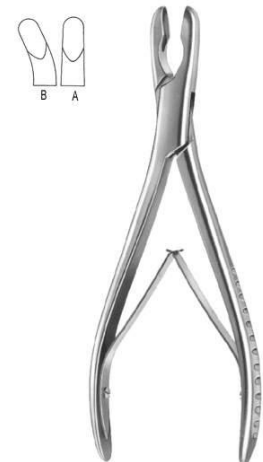

Luer

NI-7-221-17

Bone Rongeur
18 cm, 18.5 cm



Zaufal-Jansen

NI-7-222-18

Bone Rongeur
18 cm



Halle

NI-7-183-01

Bone Curette

21 cm Fig. 1 , 21 cm Fig. 2, 21 cm Fig. 3

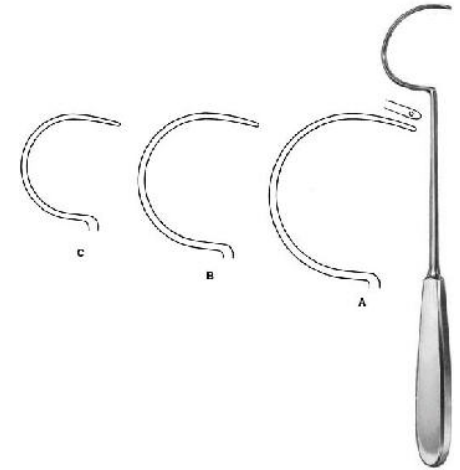

Demel

NI-7-124-01

Wire Guide
31 cm Fig. 1



Volkmann

NI-7-184-01

Bone Curette, double-ended
12.5 cm, 14.5 cm , 17 cm



Volkmann

NI-7-185-13

Bone Curette, double-ended
13 cm , 16 cm



Bone Curette

NI-7-186-21

Bone Curette, double-ended
21 cm



Williger

NI-7-187-00

Bone Curette, double-ended
13.5 cm Fig. 00/0 , 13.5 cm Fig. 0/1 , 13.5 cm Fig. 1/2



Hemingway

NI-7-189-11

Bone Curette, double-ended
18 cm

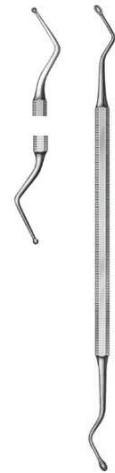

Hemingway

NI-7-190-00

Bone Curette, double-ended
18.5 cm



Bone Curette

NI-7-191-01

Bone Curette, double-ended
17.5 cm

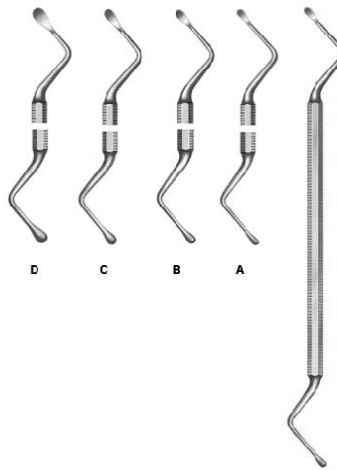

Lucas

NI-7-192-11

Bone Curette, double-ended
18 cm

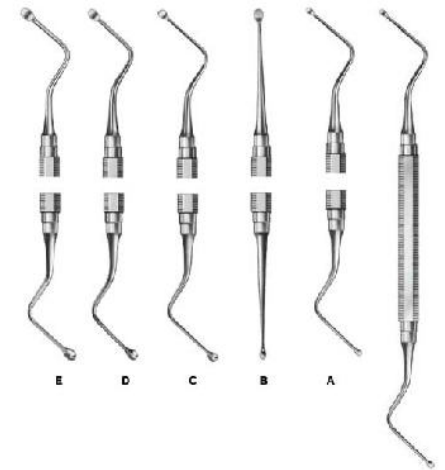

Miller-Colburn

NI-7-193-00

Bone Curette, double-ended
17 cm Fig. 0, 17 cm Fig. 1 , 17 cm Fig. 2 , 17 cm Fig. 3

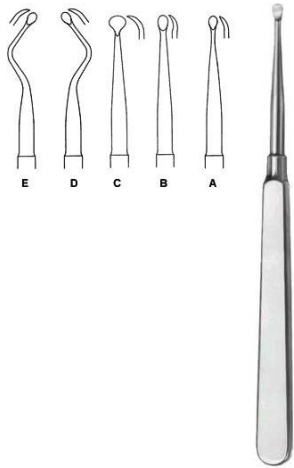

Molt

NI-7-194-01

Bone Curette

17 cm Fig. 1 , 17 cm Fig. 2 , 17 cm Fig. 3 ,
17 cm Fig. 4

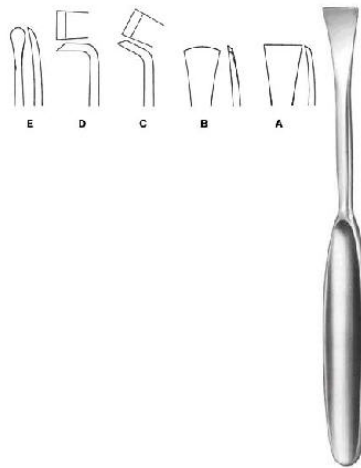

Martin-Langenbeck

NI-7-195-01

Periosteal Elevator

19 cm 16mm



Langenbeck

NI-7-196-18

Periosteal Elevator

18.5 cm



Langenbeck

NI-7-197-19

Periosteal Elevator

19.5 cm



Periosteal Elevator

NI-7-198-05

Periosteal Elevator

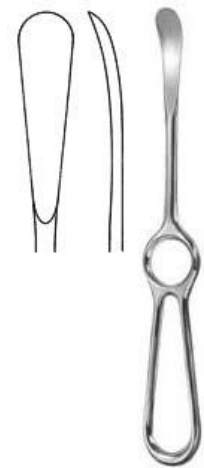

Sedillot

NI-7-199-21

Periosteal Elevator

22 cm 15mm



Williger

NI-7-200-13

Periosteal Elevator
12.5 cm 5mm



Kahre-Williger

NI-7-201-04

Periosteal Elevator
4 mm, 5 mm, 7 mm

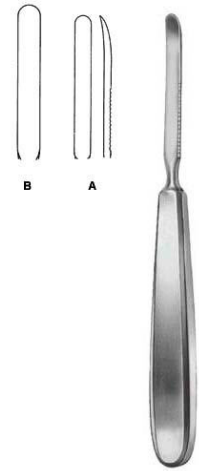

Periosteal Elevato

NI-7-202-06

Periosteal Elevato
17 cm 6mm , 17 cm 8mm



Doyen

NI-7-203-17

Rib Raspatory
17.5 cm

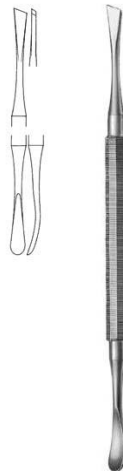

West

NI-7-204-19

Periosteal Elevator, double-ended
18.5 cm

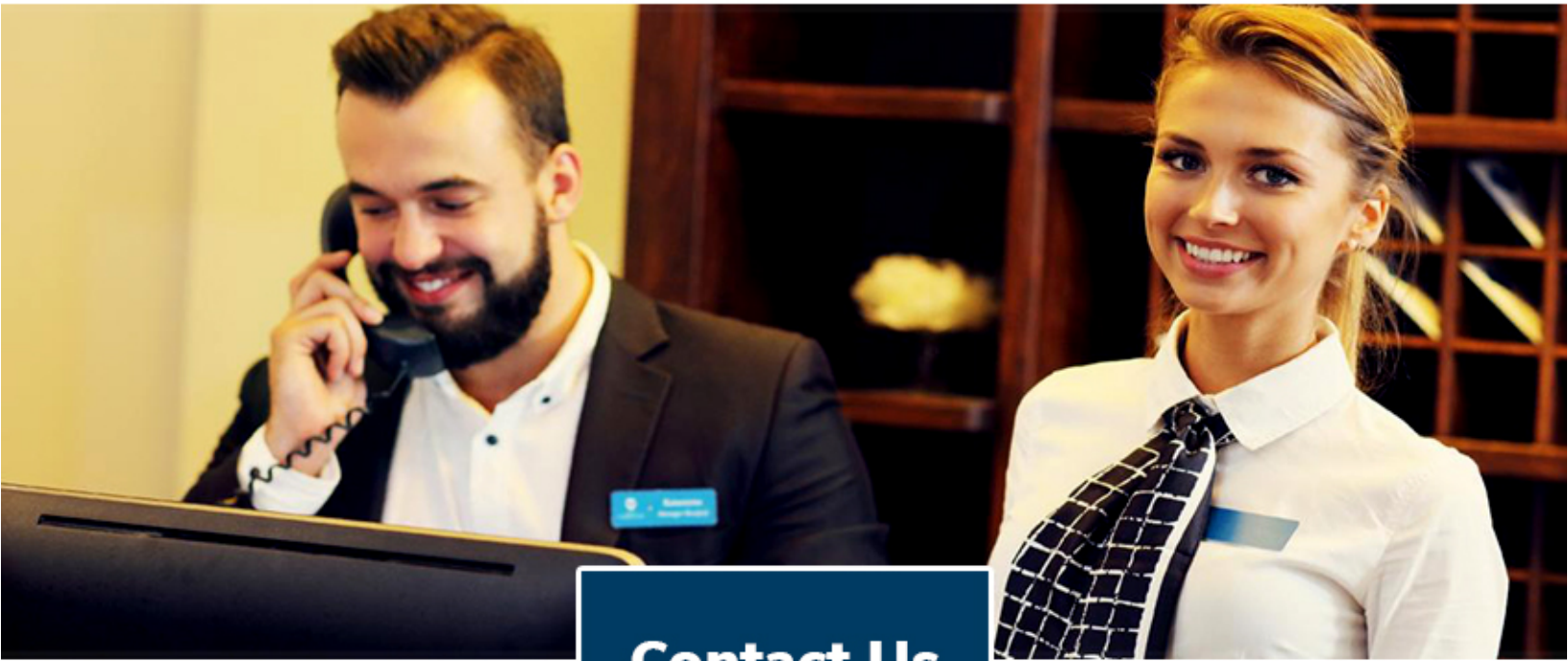

Contact Us

Serving Your Health With Excellence

Address: Gohad Pur West, Sialkot - 51310, Pakistan.

Tell: +92 524 269926

E-mail: info@noxbay.com, noxbay@gmail.com